

DVF-3060/3060-S

DVF-3060K-S

SERVICE MANUAL

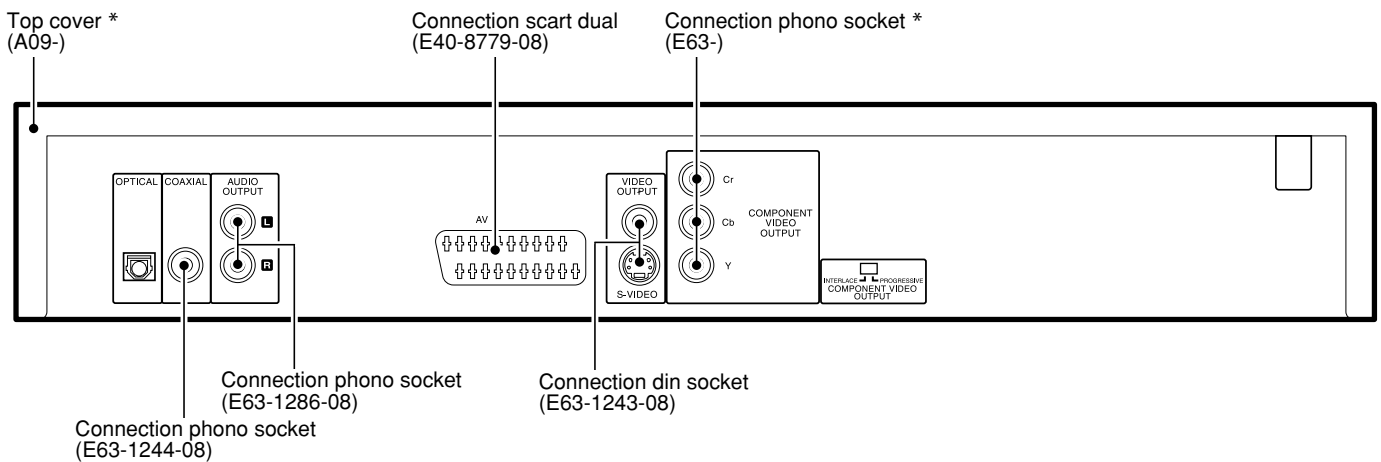
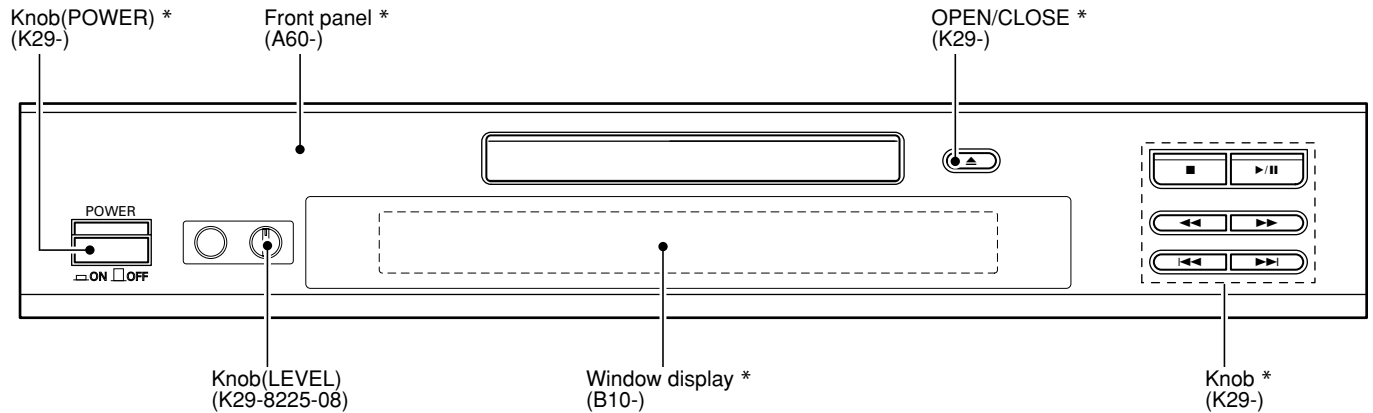

Figure is DVF-3060K.
* Refer to parts list on page 16.

In compliance with Federal Regulations, following are reproduction of labels on, or inside the product relating to laser product safety.

Caution : No connection of ground line if disassemble the unit. Please connect the ground line on rear panel, PCBs, Chassis and some others.

KENWOOD-Corp. certifies this equipment conforms to DHHS Regulations No.21 CFR 1040. 10, Chapter 1, subchapter J.

DANGER : Laser radiation when open and interlock defeated. AVOID DIRECT EXPOSURE TO BEAM.



DVF-3060/3060-S/3060K-S

CONTENTS / ACCESSORIES / CAUTIONS

Contents

CONTENTS / ACCESSORIES / CAUTIONS.....	2	SCHEMATIC DIAGRAM	13
DISASSEMBLY FOR REPAIR.....	3	EXPLODED VIEW	19
CIRCUIT DESCRIPTION	4	PARTS LIST.....	20
PC BOARD	9	SPECIFICATIONS	25

Accessories

Please confirm that the following accessories are present.

Audio video cord (Red, White, Yellow) ... (1)
(E30-2990-08)

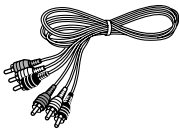

Remote control unit (1)

DV-603/DVF-3060
(A70-1532-08)

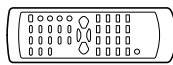

DVF-3060K
(A70-1592-08)

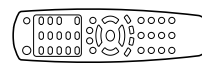

Coaxial cable ... (1)
(E30-7235-08)

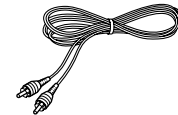

Batteries (2)

DV-603/DVF-3060 (R6/AA)

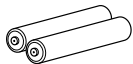

DVF-3060K (R03/AAA)



AC Plug Adaptor (1)
(E03-0115-05)

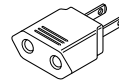

Use to adapt the plug on the power cord to the shape of the wall outlet.
(Accessory only for regions where use is necessary.)

Cautions

Operation to reset

The microprocessor may fall into malfunction (impossibility to operate erroneous display, etc.) when the power cord is unplugged while power is ON or due to an external factor. In this case, execute the following procedure to reset the microprocessor and return it to normal condition.

- Please note that resetting the microprocessor clears the contents stored in, it returns the microprocessor to the condition when it left the factory.

- In Power ON condition, keep the ■ (Stop) key and the ►► (Search) key pressed at the same time.
- When both keys are pressed, the region code of the unit, the software version, etc. will be displayed on the display. (When nothing is done, the display of this information continues.)
Example: 72. 14.02:05
- Press the **POWER ON/OFF** switch to go to Power OFF.
- When Power ON is performed with the **POWER ON/OFF** switch, the settings become the default factory settings.

The marking of products using lasers (For countries other than U.S.A., U.S.-Military and Canada)

CLASS 1
LASER PRODUCT

The marking this product has been classified as Class 1. It means that there is no danger of hazardous radiation outside the product.

Location: Back panel

Model vs description

MODEL	DESTINATION	COLOR
DVF-3060	E	BLACK
DVF-3060	Y	BLACK
DVF-3060-S	ETXY	SILVER
DVF-3060K-S	HM	SILVER
DVF-3060K-S(M2)	M2	SILVER

DVF-3060/3060-S/3060K-S

DISASSEMBLY FOR REPAIR

How to open the tray if it does not come out.

1. Insert a flat driver and pull it down in the drawing through the hole on the loading chassis bottom.
2. Pull out the tray frontward by hand when it comes just out.

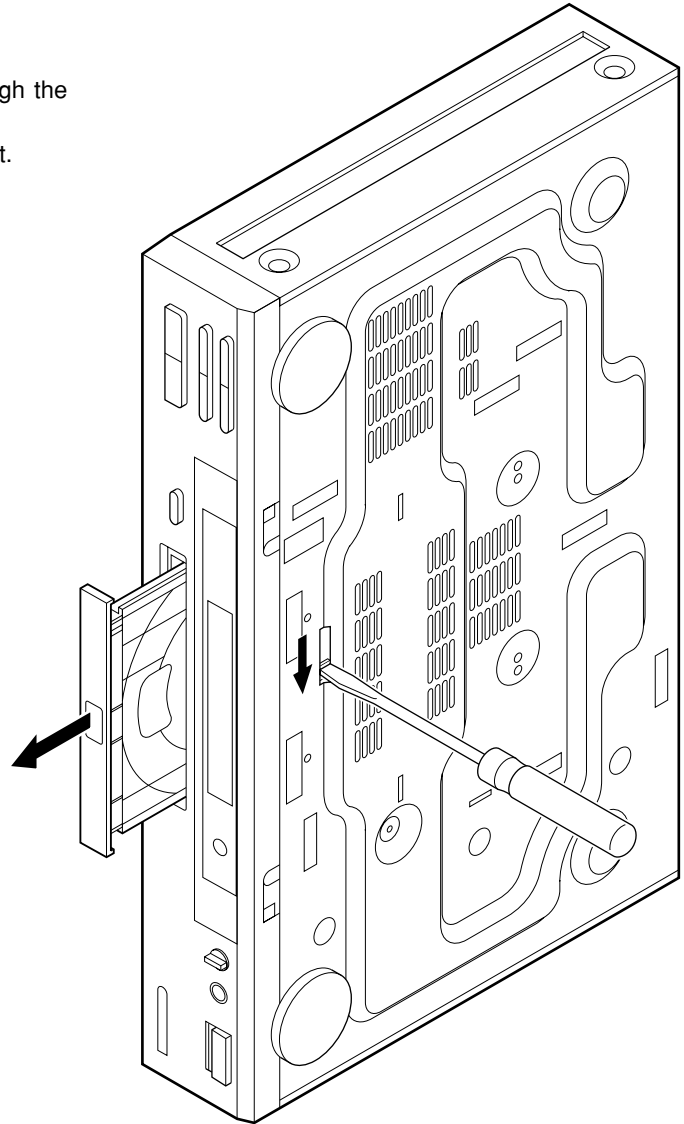

DVF-3060/3060-S/3060K-S

CIRCUIT DESCRIPTION

1. Port list sorted by function for MPEG Processor IC(Main IC21)

Port No.	Port Name	I/O	Port Description	
Audio DAC				
51	DAC SCLK (BCK)	O	DAC sampling clock.	
52	DAC PCMOUT0	O	DAC PCM data out 0.	
53	DAC PCMOUT1	O	DAC PCM out 1 (unused).	
54	DAC PCMOUT2	O	DAC PCM out 2 (unused).	
55	DAC PCMCLK	O	DAC PCM clock.	
56	DAC LRCLK	O	DAC PCM Left/Right clock.	
57	SPDIF OUT	O	Audio digital data output.	
48	VDD PCM	-	Supply voltage for PCM (+2V5).	
49	VSS PCM	-	Ground for PCM.	
Clock & Reset				
124	RESET	I	Chip reset input.	
122	VDD PLL	-	Supply voltage for PLL (+2V5).	
123	VSS PLL	-	Ground for PLL.	
120	PIX CLK	I	27MHz main clock input.	
PIOs and communication				
186	PIO0(0) T STROBE	I/O	Flash ROM down-load JIG module signal.	
187	PIO0(1) MOD SW	I/O	Flash ROM down-load JIG module signal.	
188	PIO0(2) VFD STB	O	VFD strobe output.	
189	PIO0(3) VFD CLK	O	VFD clock output.	
190	PIO0(4) VFD DATA OUT	O	VFD data output.	
191	PIO0(5) VFD DATA IN	I	Data input from VFD.	
192	PIO0(6) SLIDER SENSOR OPEN/CLOSE (DRAWER POSITION)	I/O	Detection port of slider sensor for DVD mechanism.	
193	PIO0(7) SLIDER IN (DRAWER CCW/CTRL)	I/O	Control port of slider (IN) for DVD mechanism.	
194	PIO1(0) SDA	I/O	12C serial data.	
195	PIO1(1) SCL	I/O	12C serial clock.	
196	PIO1(2) SLIDER OUT (DRAWER CW CTRL)	I/O	Control port of slider (OUT) for DVD mechanism.	
197	PIO1(3) TXD(JIG)	I/O	UART TXD	
200	PIO1(4) RXD(JIG)	I/O	UART RXD	
201	PIO1(5) FRONT TXDI	I/O	Unused.	
202	TRIGGER IN	I/O	Trigger input from JIG.	
203	TRIGGER OUT	I/O	Trigger output from JIG.	
204	PIO2(0) H/P IND	-	Unused.	
205	PIO2(1) FRONT RXD	-	Unused.	
*	206	PIO2(2) MIC DET	I	Detection port of MIC jack.
	207	PIO2(3) MIC MUTE	-	Unused.
	208	PIO2(4) AUDIO MUTE	O	Audio mute control.
	1	PIO2(5) RGB SEL(BLANK)	I/O	RGB sel (blank). E/T type only
	2	PIO2(6) VIDEO MUTE	I/O	Video mute control.
	3	PIO2(7) 16: 9 INDICATOR	I/O	16 : 9 indicator (E/T type only)
	6	PIO3(0) SCART H (TV/AUX)	I/O	Unused.
	7	PIO3(1)	I/O	Unused.
*	8	PIO3(2) CSB	O	3-wire MPU chip select/2-wire MPU interface address selection.
*	9	PIO3(3) SDIN	O	3-wire MPU data output /2-wire MPU data output.
	10	PIO3(4) IR REMOCON	I/O	IR Remote controller signal output.
*	11	PIO3(5) SCLK	O	3-wire MPU clock output /2-wire MPU clock output.
	12	PIO3(6)	I/O	Unused
	13	PIO3(7) DVD RESET	I/O	Power- on reset of front-end module.
	39	PIO4(0)HP MUTE	-	Unused.
	40	PIO4(1)	-	Unused.
	41	PIO4(2) DAC SCKDSD	O	DAC system clock output

DVF-3060/3060-S/3060K-S

CIRCUIT DESCRIPTION

Port No.	Port Name	I/O	Port Description
42	PIO4(3) DAC SDIDEM	O	DAC data output.
43	PIO4(4) DAC MUTE B	O	DAC mute control.
44	PIO4(5) DAC LAT12S	O	DAC latch output.
45	PIO4(6) DAC CSBIWL	O	DAC chip select.
46	PIO4(7) ZERO	I/O	Zero data flag.
Reserved			
20	B WCLK	I/O	Unused.
21	B V4	I/O	Unused.
22	NRSS OUT	I/O	Unused.
* 103	ADC SCLK	I/O	Digital audio port clock.
* 104	ADC LRCLK	I/O	ADC sample rate clock
* 105	ADC DATA	I	ADC digital audio data input.
* 106	ADC PCMCLK	O	Crystal input or master clock input (MCLK).
EMI Interface			
161~170	CPU ADR(1~10)	O	Flash ROM address (1~10).
173~183	CPU ADR(11~21)	O	Flash ROM address (11~21).
141~148	CPU DATA(0~7)	I/O	Flash ROM data input/output (0~7).
151~158	CPU DATA(8~15)	I/O	Flash ROM data input/output (8~15).
138	CPU RAS1	I/O	Unused.
131	CPU WAIT	I	Wait state (connected to be ground).
130	CPU RW	O	Unused.
128	CPU BE(0)	O	Flash ROM write enable.
129	CPU BE(1)	O	Unused.
139	CPU CAS0	O	Unused.
140	CPU CAS1	O	Unused.
135	CPU CE(0)	O	Unused.
134	CPU CE(1)	O	Unused.
133	CPU CE(2)	O	Flash ROM down-load JIG module select.
132	CPU CE(3)	O	Flash ROM chip select.
118	CPU PRO CLK	O	SDRAM clock (unused).
117	CPU OE	I/O	Flash ROM output enable.
Interrupt			
127	IRQ(0)	I	Unused.
126	IRQ(1)	I	Unused.
125	IRQ(2)	I	Interrupt request 2 from front-end module.
Timers			
116	PWM0	I/O	Unused.
115	PWM1	I/O	ROM boot option port (voltage low = emulator booting).
114	PWM2	I/O	Unused.
JTAG			
113	TCK	I	Test clock input from emulator module.
112	TDI	I	Test data input from emulator module.
111	TDO	O	Test data out to emulator module.
110	TMS	I	Test mode select.
109	TRST4	I	Test reset from emulator module.
Front-end			
16	B DATA	I	Pack data of front-end serial data.
17	B BCLK	I	Bit clock of front-end serial data.
18	B FLAG	I	Pack clock of front-end serial data.
19	B SYNC	I	Sector start of front-end serial data.
Video DAC			
27,26,25	R/G/B (OUT)	O	R/G/B signal outputs.
32~34	Y/C/CV (OUT)	O	Y/C/CV signal outputs.
29	I REF RG	I	Reference current input for DAC RGB.
28	V REF RG	I	Reference voltage input for DAC RGB.

DVF-3060/3060-S/3060K-S

CIRCUIT DESCRIPTION

Port No.	Port Name	I/O	Port Description
36	I REF YCC	I	Reference current input for DAC YCC.
35	V REF YCC	I	Reference voltage input for DAC YCC.
23	VDD RGB	-	Supply voltage for RGB (+2.5VA).
24	VSS RGB	-	GND
30	VDD YCC	-	Supply voltage for YCC (+2.5VA).
31	VSS YCC	-	GND
Shared memory interface			
66~69	SMI ADR(3~0)	O	SDRAM address bus.
58~63	SMI ADR(4~9)	O	SDRAM address bus.
70~73	SMI ADR(10~13)	O	SDRAM address bus.
84~93 97~102	SMI DATA(0~9) SMI DATA(10~15)	I/O	SDRAM data bus.
74	SMI CS(0)	O	Chip select bank 0.
75	SMI CS(1)	-	Unused.
76	SMI RAS	O	SDRAM RAS
77	SMI CAS	O	SDRAM CAS
78	SMI WE	O	SDRAM write enable
79	SMI DQML	O	DQ MASK enable low.
80	SMI DQMU	O	DQ MASK enable up.
82	SMI CLKIN	I	SDRAM clock input.
95	SMI CLKOUT	O	SDRAM clock out.
Power supply			
4,47,81,107 136,159,184	VDD3 3	-	3.3V Power supply.
14,37,64,94 119,149,171 198	VDD2 5	-	2.5V Power supply.
5,15,38,50,65 83,96,108,121 137,150,160 172,185,199	VSS	-	GND

* M type only

2. Description of Ics

2-1 VFO controller : uPD16311(IC91)

Pin No.	Pin Name	I/O	Pin Description
6	DIN	I	Inputs serial data at rising edge of shift clock, starting from lower bit.
5	DOUT	O	Output serial data at falling edge of shift clock, starting from lower bit. This is N-ch open-drain output pin.
9	STB	-	Strobe pin.
8	CLK	I	Reads serial data at rising edge, and output data at falling edge.
52	OSC	-	Connect resistor for determining oscillation frequency to this pin.
15~26	S1/KS1~S12/KS12	O	Segment output pins (Dual function as key source).
35~44	G10~G1	O	Grid output pins.
27~30 31,32	S13~S16 12G,11G	O	These pins are selectable for segment or grid output.
46,47,49,50	LED (5,4,2,1)	O	Unused.
48	LED3	O	Control pin of standby LED.
10~13	KEY1~KEY4	I	Data input to these pins is latched at end of display cycle.
1~4	N.C.	-	Unused.
14,33,45	VDD	-	+5V power supply.
51	VSS	-	Connect this pin to GND of system.
34	VEE	-	-27V power supply.
7	N.C.	-	Unused.

DVF-3060/3060-S/3060K-S

CIRCUIT DESCRIPTION

2-2 HEX Inverter (Single Stage) : M74HCU04(IC51)

Pin No.	Pin Name	I/O	Pin Description
1,3,5,9,11,13	A0 to A5	I	Data Inputs
2,4,6,8,10,12	Q0 to Q5	O	Data Outputs
7	GND	-	Ground
14	VCC	-	Positive Supply Voltage

Truth Table

A	Q
L	H
H	L

2-3 Flash Memory : M29W 800AT

Pin No.	Pin Name	I/O	Pin Description
1~8	A15~A8	I	Address Inputs
9,10	N.C.	-	Unused
11	WE	-	Write Enable
12	RP	-	Reset/Block Temporary Unprotect
13,14	N.C.	-	Unused
15	RY/BY	O	Ready/Busy/Output
16,17	A18,A17	I	Address Inputs
18~25	A7~A0	I	Address Inputs
26	CE	-	Chip Enable
27,46	VSS	-	Ground
28	QE	-	Output Enable
29~36 38~45	DQ0~DQ15	I/O	Data Input/Outputs, Command Inputs
37	VCC	-	Supply Voltage
45	DQ15	I/O	Data Input/Outputs or Address input
47	BYTE	-	Byte/Word Organization
48	A16	I	Address Inputs

2-4 DC Motor Driver : KA8082(IC23)

Pin No.	Pin Name	I/O	Pin Description
1	GND	-	Ground
2	VO1	O	Output 1
3	VCTL	I	Motor speed control
4	VIN1	I	Input 1
5	VIN2	I	Input 2
6	SVCC	-	Supply voltage (Signal)
7	PVCC	-	Supply voltage (Power)
8	VO2	O	Output 2

2-5 64 Bit SDRAM : HY57V641620HGT

Pin No.	Pin Name	I/O	Pin Description
1,14,27,	VCC	-	Power supply for internal circuits and input buffers.
2,4,5,7,8,10 11,13,42,44 45, 47,48,5051,53	DQ0~DQ15	I/O	Multiplexed data input/output pin.
3,9,43,49	VCCQ	-	Power supply for output buffers.
6,12,46,52	VSSQ	-	Ground for output buffer.
15,39	LDQM,UDQM	I/O	Controls output buffers in read mode and masks input data in write mode.
16,17,18	WE,CAS,RAS	-	WE, CAS and RAS define the operation.
19	CS	-	Enables or disables all inputs except CLK, CKE, and DQM.
20,21	BA0,BA1	-	Selects bank to be activated during RAS activity. Selects bank to be read/written during CAS activity.
22,23~26 29~34,35	A10, A0~A3 A4~A9, A11	-	Address bus : A0~A11
28,41,54	VSS	-	Ground for internal circuits and input buffers.
36,40	NC	-	Unused.
37	CKE	-	Controls internal clock signal and when deactivated, the SDRAM will be one of the states among power down, suspend or self refresh.
38	CLK	I	The system clock input. all other inputs are registered to the SDRAM on the rising edge of CLK.

DVF-3060/3060-S/3060K-S

CIRCUIT DESCRIPTION

2-6 Stereo Audio ADC : VM8739 (Main KIC1) M Type only

Pin No.	Pin Name	I/O	Pin Description
1	SDIN	I	3-wire MPU data input/2-wire MPU data input.
2	SCLK	I	3-wire MPU clock input/2-wire MPU clock input.
3	XTI/MCLK	I	Crystal input or master clock input (MCLK).
4	XTO	O	Crystal output.
5	DCVDD	-	Digital core VDD.
6	DGND	-	Digital GND.
7	DBVDD	-	Digital buffers VDD.
8	BCLK	I/O	Digital audio port clock.
9,10	DNC	-	Unused.
11	ADCDAT	O	ADC digital audio data output.
12	ADCLRC	I/O	ADC sample rate clock.
13	NC	-	Unused.
14	AVDD	-	Analog VDD.
15	AGND	-	Analog GND.
16	VMID	O	Mid-rail reference decoupling point.
17	RLINEIN	I	Right channel line input (AC coupled).
18	LLINEIN	I	Left channel line input (AC coupled).
19	MODE	I	Control interface selection, pull up (on power up only).
20	CSB	I	3-wire MPU chip select/2-wire MPU interface address selection.

2-7 24-bit, 192kHz Stereo DAC : WM8728 (Rear/Scart Board IC81)

Pin No.	Pin Name	I/O	Pin Description
1	LRCIN	I	DAC sample rate clock input : PCM input mode Right channel DSD bitstream input : DSD input mode
2	DIN	I	Serial audio data input : PCM input mode Left channel DSD bitstream input : DSD input mode
3	BCKIN	I	Audio data bit clock input.
4	MCLK	I	Master clock input.
5	ZERO	O	Infinite zero detect flag.
6	DGND	-	Digital ground supply.
7	DVDD	-	Digital positive supply.
8	VOUTR	O	Right channel DAC output.
9	AGND	-	Analog ground supply.
10	AVDD	-	Analog positive supply.
11	VOUTL	O	Left channel DAC output.
12	VMID	O	Mid rail decoupling point.
13	VREFN	-	DAC negative reference.
14	VREFP	-	DAC positive reference.
15	CSBIWL	I	Software mode : 3-wire serial control chip select Hardware mode : Input word length
16	MODE	I	Control mode selection.
17	MUTEB	-	Mute control. "L" = Mute on, "H" = Mute off"
18	SDIDEM	-	Software mode : 3 or 2-wire serial control data input Hardware mode : De-Emphasis select
19	SCKDSD	I	Software mode : 3 or 2-wire serial control clock input Hardware mode : DSD bitstream operation select
20	LAT12S	I	Software mode : 3-wire serial control load input Hardware mode : Input data format selection

PC BOARD (Component side view)

MAIN BOARD (SIDE A)

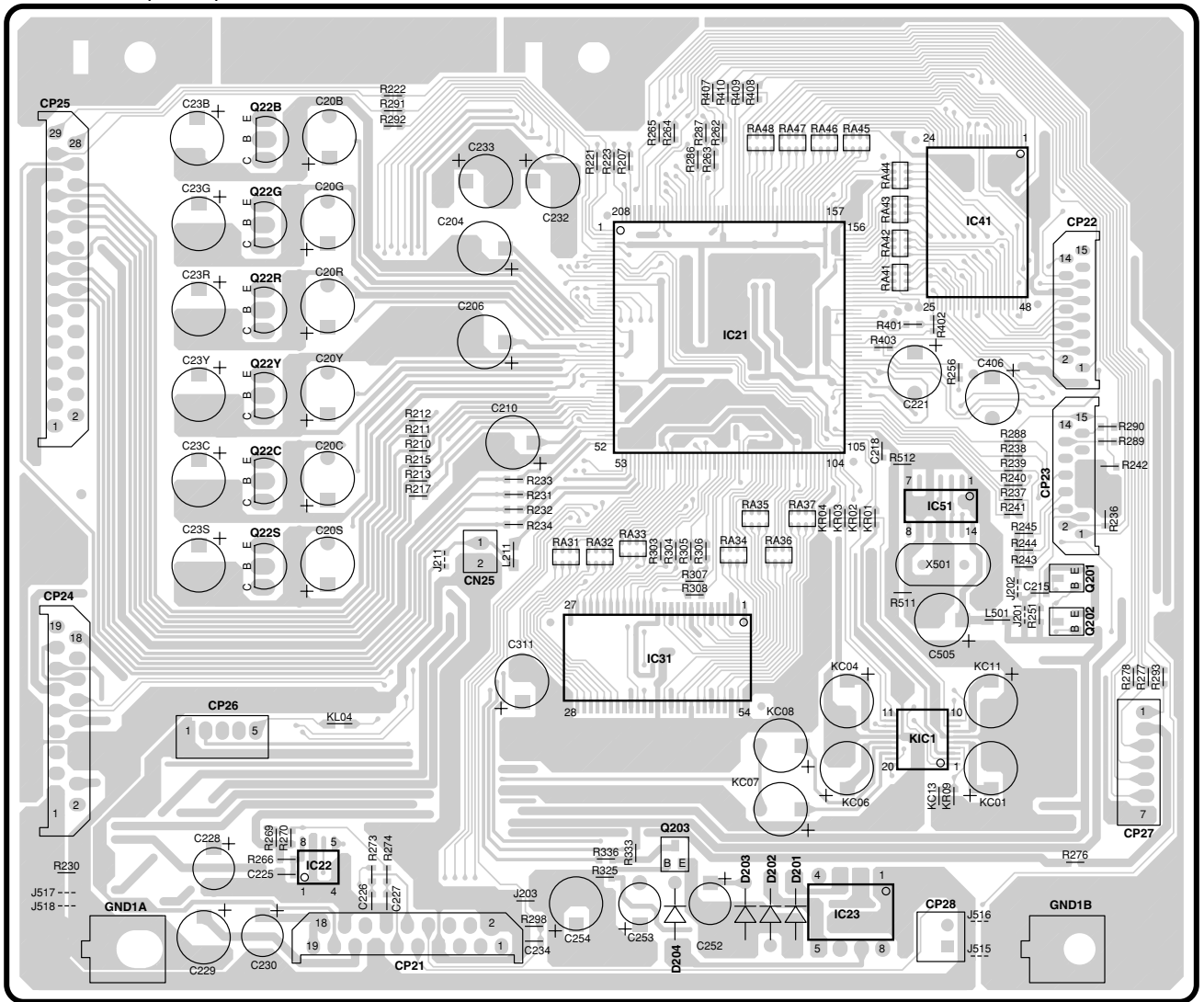

Refer to the schematic diagram for the value of resistors and capacitors.

PC BOARD (Component side view)

MAIN BOARD (SIDE B)

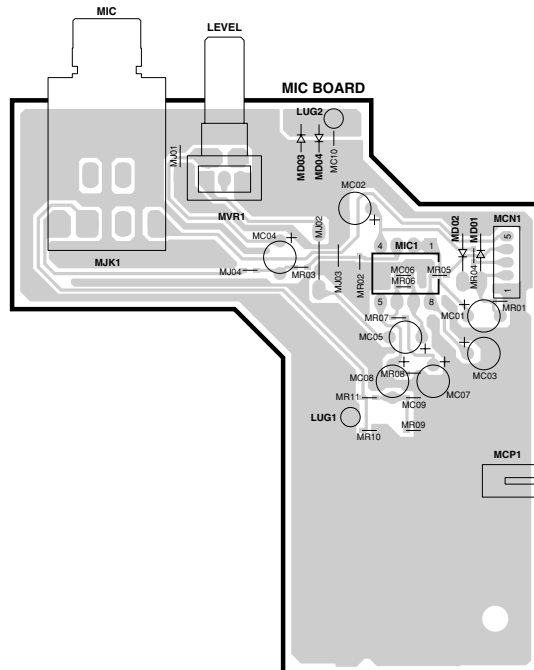
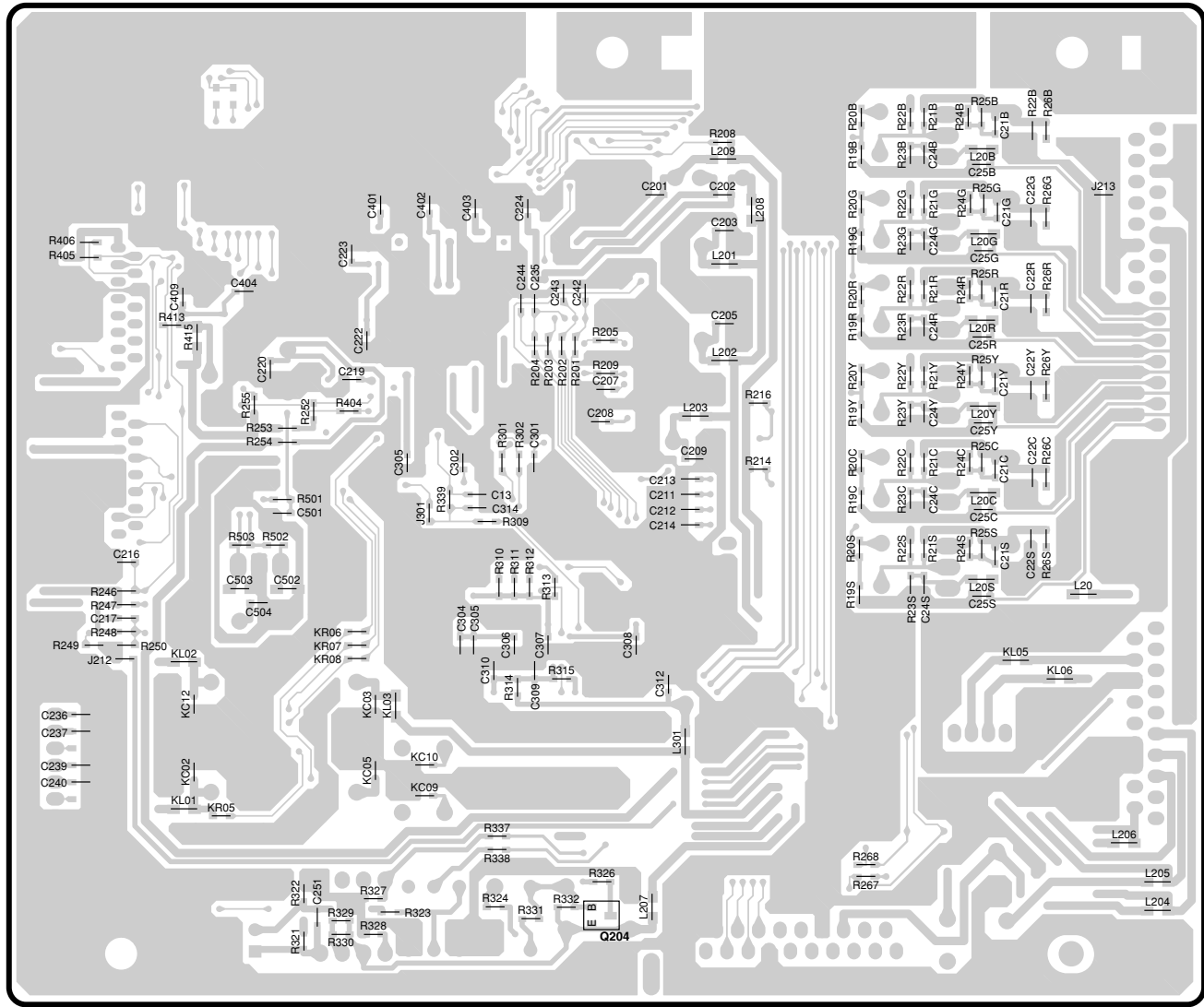

Refer to the schematic diagram for the value of resistors and capacitors.

PC BOARD(Component side view)

FRONT BOARD

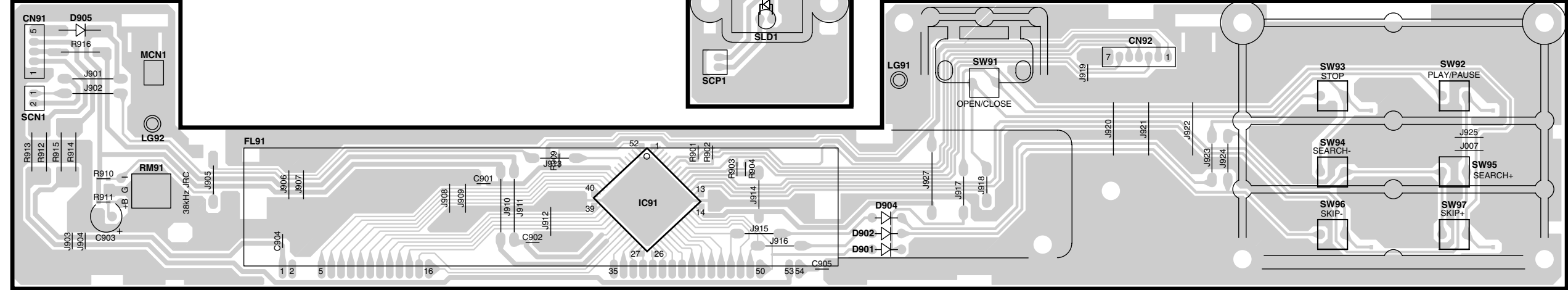

REAR/SCART BOARD

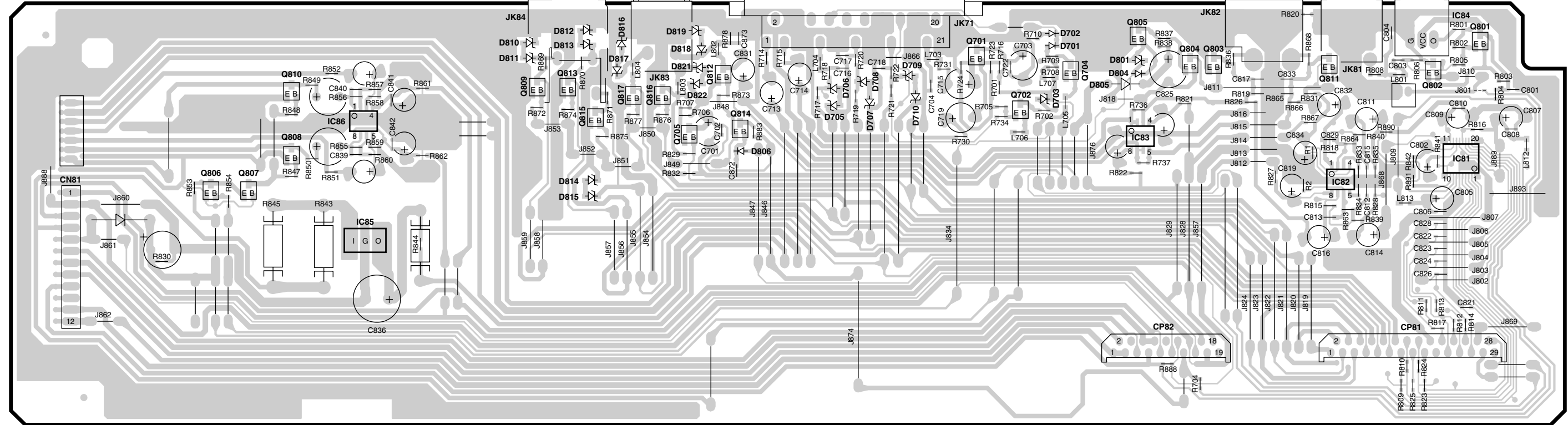

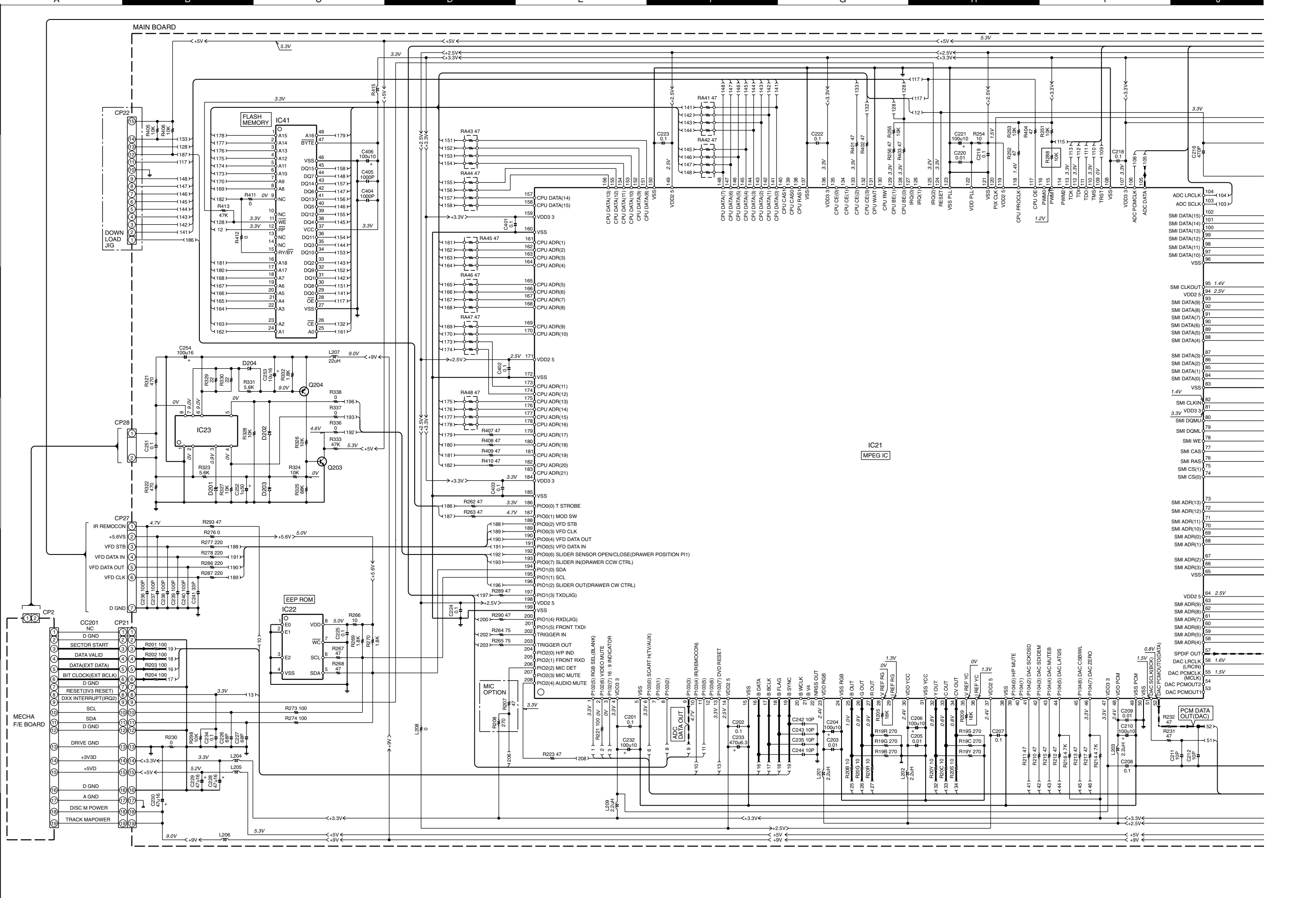

MAIN BOARD

DOWN LOAD JIG

CP28

CP27

CP21

MECHA F/E BOARD

FLASH MEMORY IC41

EEP ROM IC22

IC21 MPEG IC

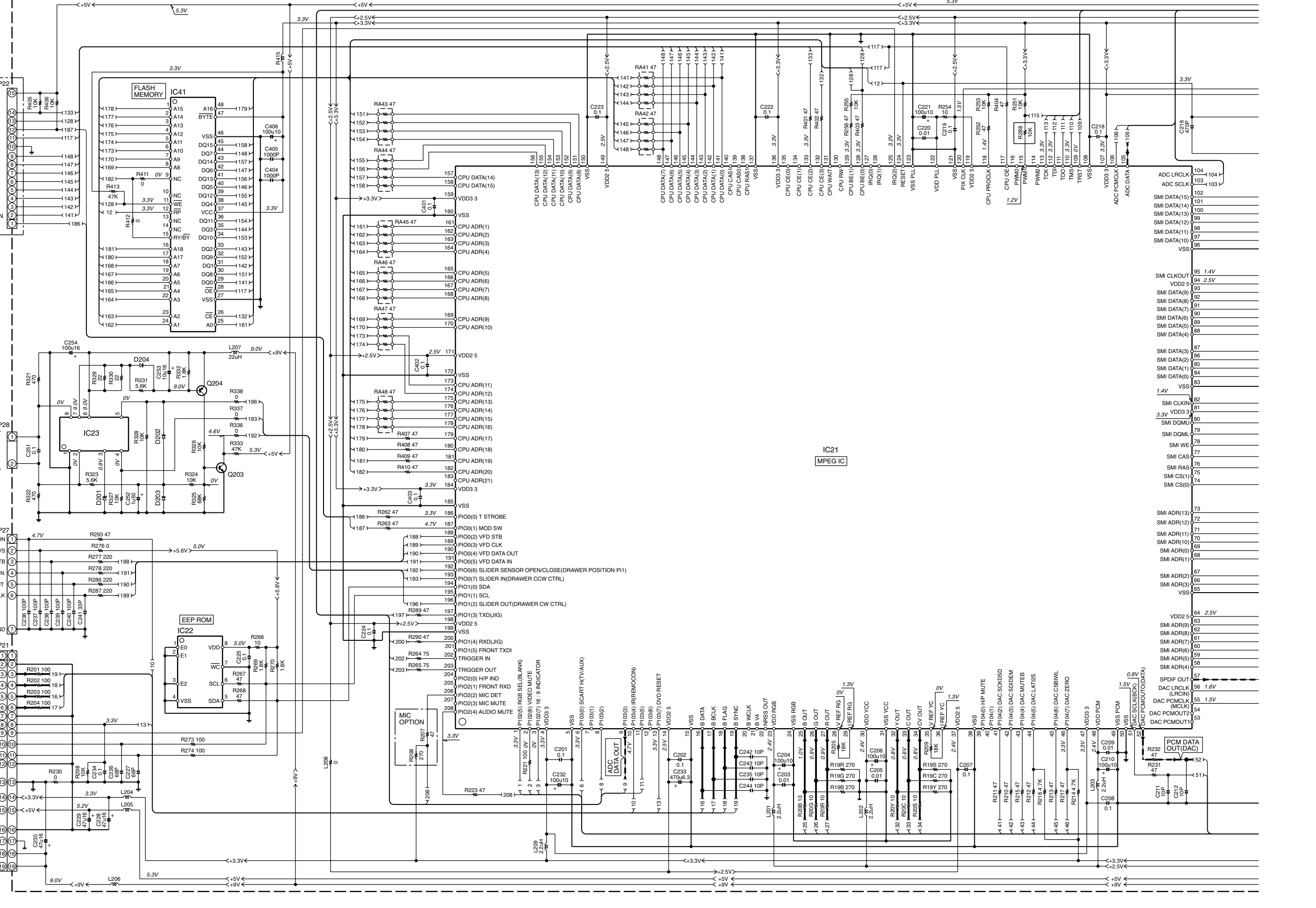

5V

3.3V

5.3V

3.3V

5.3V

3.3V

5.3V

3.3V

5.3V

3.3V

5.3V

3.3V

5.3V

3.3V

5.3V

3.3V

5.3V

3.3V

5.3V

3.3V

5.3V

3.3V

5.3V

3.3V

5.3V

3.3V

5.3V

3.3V

5.3V

3.3V

5.3V

3.3V

5.3V

3.3V

5.3V

3.3V

5.3V

3.3V

5.3V

3.3V

5.3V

3.3V

5.3V

3.3V

5.3V

3.3V

5.3V

3.3V

5.3V

3.3V

5.3V

3.3V

5.3V

3.3V

5.3V

3.3V

5.3V

3.3V

5.3V

3.3V

5.3V

3.3V

5.3V

3.3V

5.3V

3.3V

5.3V

3.3V

5.3V

3.3V

5.3V

3.3V

5.3V

3.3V

5.3V

3.3V

5.3V

3.3V

5.3V

3.3V

5.3V

3.3V

5.3V

3.3V

5.3V

3.3V

5.3V

3.3V

5.3V

3.3V

5.3V

3.3V

5.3V

3.3V

5.3V

3.3V

5.3V

3.3V

5.3V

3.3V

5.3V

3.3V

5.3V

3.3V

5.3V

3.3V

5.3V

3.3V

5.3V

3.3V

5.3V

3.3V

5.3V

3.3V

5.3V

3.3V

5.3V

3.3V

5.3V

3.3V

5.3V

3.3V

5.3V

3.3V

5.3V

3.3V

5.3V

3.3V

5.3V

3.3V

5.3V

3.3V

5.3V

3.3V

5.3V

3.3V

5.3V

3.3V

5.3V

3.3V

5.3V

3.3V

5.3V

3.3V

5.3V

3.3V

5.3V

3.3V

5.3V

3.3V

5.3V

3.3V

5.3V

3.3V

5.3V

3.3V

5.3V

3.3V

5.3V

3.3V

5.3V

3.3V

5.3V

3.3V

5.3V

3.3V

5.3V

3.3V

5.3V

3.3V

5.3V

3.3V

5.3V

3.3V

5.3V

3.3V

5.3V

3.3V

5.3V

3.3V

5.3V

3.3V

5.3V

3.3V

5.3V

3.3V

5.3V

3.3V

5.3V

3.3V

5.3V

3.3V

5.3V

3.3V

5.3V

3.3V

5.3V

3.3V

5.3V

3.3V

5.3V

3.3V

5.3V

3.3V

5.3V

3.3V

5.3V

3.3V

5.3V

3.3V

5.3V

3.3V

5.3V

3.3V

5.3V

3.3V

5.3V

3.3V

5.3V

3.3V

5.3V

3.3V

5.3V

3.3V

5.3V

3.3V

5.3V

3.3V

5.3V

3.3V

5.3V

3.3V

5.3V

3.3V

5.3V

3.3V

5.3V

3.3V

5.3V

3.3V

5.3V

3.3V

5.3V

3.3V

5.3V

3.3V

5.3V

3.3V

5.3V

3.3V

5.3V

3.3V

5.3V

3.3V

5.3V

3.3V

5.3V

3.3V

5.3V

3.3V

5.3V

3.3V

5.3V

3.3V

5.3V

3.3V

5.3V

3.3V

5.3V

3.3V

5.3V

3.3V

5.3V

3.3V

5.3V

3.3V

5.3V

3.3V

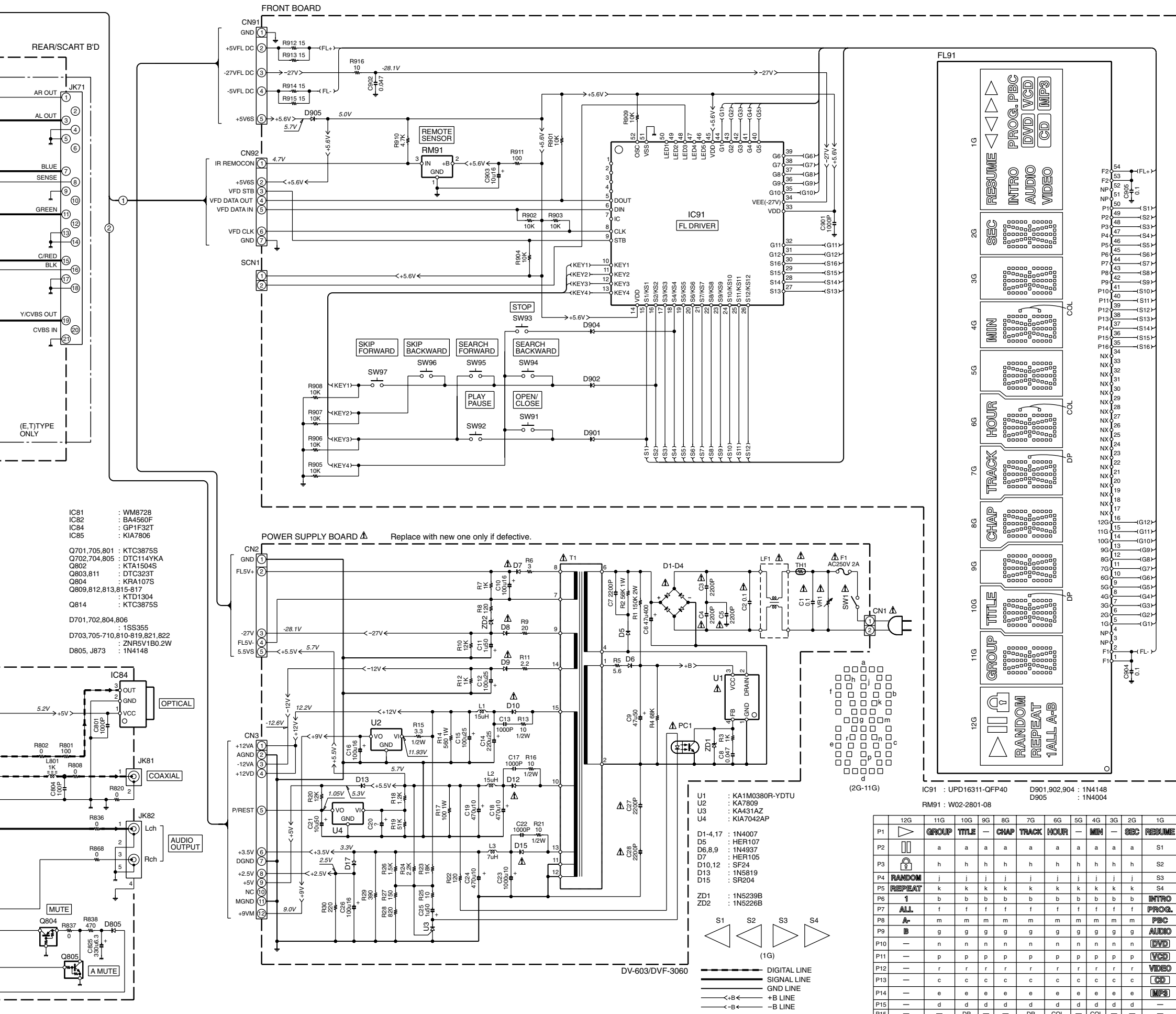

CAUTION: For continued safety, replace safety critical components only with manufacturer's recommended parts (refer to parts list). Δ indicates safety critical components. For continued protection against risk of fire, replace only with same type and rating fuse(s). To reduce the risk of electric shock, leakage-current or resistance measurements shall be carried out (exposed parts are acceptably insulated from the supply circuit) before the appliance is returned to the customer.

The DC voltage is an actual reading measured with a high impedance type voltmeter with no signal input. The measurement value may vary depending on the measuring instruments used or on the product.

IC91 : UPD16311-QFP40
 RM91 : W02-2801-08
 D901,902,904 : 1N4148
 D905 : 1N4004

	12G	11G	10G	9G	8G	7G	6G	5G	4G	3G	2G	1G
P1	▶	▶	▶	▶	▶	▶	▶	▶	▶	▶	▶	▶
P2	▶	▶	▶	▶	▶	▶	▶	▶	▶	▶	▶	S1
P3	▶	▶	▶	▶	▶	▶	▶	▶	▶	▶	▶	S2
P4	▶	▶	▶	▶	▶	▶	▶	▶	▶	▶	▶	S3
P5	▶	▶	▶	▶	▶	▶	▶	▶	▶	▶	▶	S4
P6	▶	▶	▶	▶	▶	▶	▶	▶	▶	▶	▶	▶
P7	▶	▶	▶	▶	▶	▶	▶	▶	▶	▶	▶	▶
P8	▶	▶	▶	▶	▶	▶	▶	▶	▶	▶	▶	▶
P9	▶	▶	▶	▶	▶	▶	▶	▶	▶	▶	▶	▶
P10	▶	▶	▶	▶	▶	▶	▶	▶	▶	▶	▶	▶
P11	▶	▶	▶	▶	▶	▶	▶	▶	▶	▶	▶	▶
P12	▶	▶	▶	▶	▶	▶	▶	▶	▶	▶	▶	▶
P13	▶	▶	▶	▶	▶	▶	▶	▶	▶	▶	▶	▶
P14	▶	▶	▶	▶	▶	▶	▶	▶	▶	▶	▶	▶
P15	▶	▶	▶	▶	▶	▶	▶	▶	▶	▶	▶	▶
P15	▶	▶	▶	▶	▶	▶	▶	▶	▶	▶	▶	▶

DVF-3060/3060-S/3060K-S

DVF-3060/3060-S/3060K-S EXPLODED VIEW (UNIT)

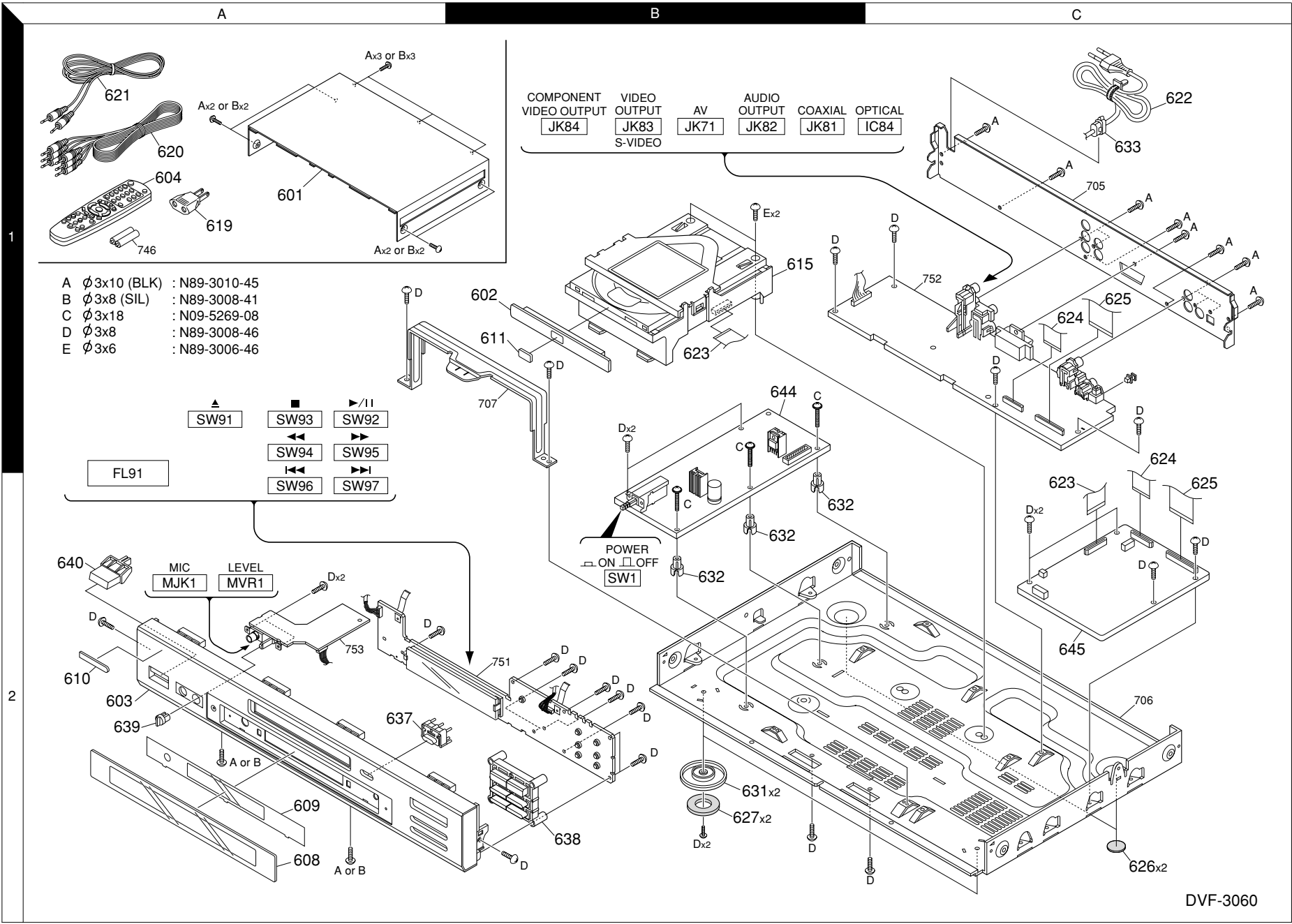

DVF-3060

Parts with exploded numbers larger than 700 are not supplied.

* New Parts
 Parts without **Parts No.** are not supplied.
 Les articles non mentionnés dans le **Parts No.** ne sont pas fournis.
 Teile ohne **Parts No.** werden nicht geliefert.



Ref. No	Address	New Parts	Parts No.	Description	Destination	Remarks
DV-603/DVF-3060/DVF-3060-S/DVF-3060K-S						
601	1A	*	A09-1269-08	COVER TOP -BK	55266340	KPEY B
601	1A	*	A09-1270-08	COVER TOP -S	55269550	ETXY S
601	1A	*	A09-1270-08	COVER TOP -S	55269550	HMM2 S
602	1B	*	A29-1206-08	DOOR TRAY -BK	55262410	KPEY S
602	1B	*	A29-1207-08	DOOR TRAY -S	55269400	ETXY S
602	1B	*	A29-1207-08	DOOR TRAY -S	55269400	HMM2 S
603	2A	*	A60-2272-08	PANEL FRONT -BK	55269770	EY B
603	2A	*	A60-2273-08	PANEL FRONT -S	55269350	ETXY S
603	2A	*	A60-2275-08	PANEL FRONT K-S	55269360	HMM2 S
603	2A	*	A60-2276-08	PANEL FRONT 603	55262390	KP S
604	1A	*	A70-1532-08	REMOTE CONTROL	55235390	KPETXY
604	1A	*	A70-1592-08	REMOTE CONTROL	55330330	HMM2
608	2A	*	B10-3872-08	WINDOW DISPLAY	55330230	EY B
608	2A	*	B10-3873-08	WINDOW DISPLAY	55346790	ETXY S
608	2A	*	B10-3873-08	WINDOW DISPLAY	55346790	HMM2 S
608	2A	*	B10-3874-08	WINDOW DISPLAY	55266230	KP S
609	2A	*	B11-1560-08	WINDOW FILTER	55266220	
610	2A	*	B43-0302-04	KENWOOD BADGE	55220500	
611	1B	*	B43-0333-08	DVD-VIDEO BADGE	55266270	
-	-	-	B46-0096-53	CARD WARRANTY	55195100	X
-	-	-	B46-0310-03	CARD WARRANTY	55213810	ET
-	-	-	B46-0328-03	LIMITED WARRANT	55218520	Y
-	-	-	B46-0336-03	CARD WARRANTY	55235440	P
-	-	-	B46-0365-04	CARD QUESTION	55373590	KP
-	-	-	B59-1104-00	CARD ADDRES(PX)	55219940	Y
-	-	*	B60-5233-08	BOOK INST(EN)	55398740	KPETXY
-	-	*	B60-5233-08	BOOK INST(EN)	55398740	MM2
-	-	*	B60-5234-08	BOOK INST(FR)	55398840	PE
-	-	*	B60-5235-08	BOOK INST(GE/NE)	55399140	E
-	-	*	B60-5236-08	BOOK INST(IT/ES)	55399240	E
-	-	*	B60-5237-08	BOOK INST(TC)	55398940	M
-	-	*	B60-5238-08	BOOK INST(AR)	55399040	M2
615	1B	*	D40-1799-08	OK KIT TVM503R	10757650	
619	1A	*	E03-0115-05	AC PLUG ADAPTOR	55236070	MM2
620	1A	*	E30-2990-08	AUDIO-CABLE ST	55176530	
621	1A	*	E30-7235-08	COAXIAL	55186190	
622	1C	*	E30-7250-08	AC CORD	55190780	KPY
622	1C	*	E30-7251-08	AC CORD	55190790	EMM2
622	1C	*	E30-7252-08	AC CORD	55190800	T
622	1C	*	E30-7253-08	AC CORD	55190820	X
622	1C	*	E30-7280-08	AC CORD	55330320	H
623	1B,2C	*	E35-3382-08	FFC CABLE 19X70	55318540	
624	1C	*	E35-3383-08	FFC CABLE 19X50	55318530	
625	1C,2C	*	E35-3384-08	FFC CABLE 29X50	55318430	
626	2C	*	G11-2896-08	FOOT RUBBER R18	55266290	
627	2B	*	G11-2897-08	FOOT RUBBER F29	55266280	
-	-	*	H10-7865-08	CUSHION LEFT	55291910	
-	-	*	H10-7866-08	CUSHION RIGHT	55291930	
-	-	*	H21-1523-08	SHEET 820X820	55164920	
-	-	*	H25-1712-08	BAG 260X410	55170650	
-	-	*	H25-1739-08	BAG POLY AC COR	55259730	

L : Scandinavia K : USA P : Canada R : Mexico C : China I : Malaysia
 Y : PX(Far East,Hawaii) T : England E : Europe G : Germany V : China(Shanghai)
 B : AAFES(Europe) X : Australia Q : Russia H : Korea M : Other Areas indicates safety critical components.
B: BLACK **S: SILVER**

* New Parts
 Parts without **Parts No.** are not supplied.
 Les articles non mentionnés dans le **Parts No.** ne sont pas fournis.
 Teile ohne **Parts No.** werden nicht geliefert.



Ref. No	Address	New Parts	Parts No.	Description	Destination	Remarks
-	-	*	H50-4527-08	GIFT BOX K/P	55291940	KP Y
-	-	*	H50-4528-08	GIFT BOX Y	55294730	X
-	-	*	H50-4529-08	GIFT BOX XS	55294710	E
-	-	*	H50-4530-08	GIFT BOX E	55294610	E
-	-	*	H50-4532-08	GIFT BOX ES	55294620	B S
-	-	*	H50-4533-08	GIFT BOX TS	55294640	T
-	-	*	H50-4534-08	GIFT BOX K-S	55294650	M
-	-	*	H50-4535-08	GIFT BOX K-S/M2	55294690	M2
-	-	*	H50-4618-08	GIFT BOX YS	55346810	Y
-	-	*	H50-4630-08	GIFT BOX K-S	55374690	H S
631	2B	*	J02-1549-08	FOIL FOOT	55266310	
632	2B	*	J19-6169-08	BRKET SPACE PCB	55164980	
633	1C	*	J42-0350-08	CLAMP CORD	55125180	
637	2A	*	K29-8218-08	OPEN/CLOSE -BK	55266190	KPEY B
637	2A	*	K29-8219-08	OPEN/CLOSE -S	55269420	ETXY S
637	2A	*	K29-8219-08	OPEN/CLOSE -S	55269420	HMM2 S
638	2B	*	K29-8221-08	PLAY KEY -BK	55266210	KPEY S
638	2B	*	K29-8222-08	PLAY KEY -S	55269510	ETXY S
638	2B	*	K29-8222-08	PLAY KEY -S	55269510	HMM2 S
639	2A	*	K29-8225-08	KNOB LEVEL K-S	55304220	HMM2 S
640	2A	*	K29-8226-08	KNOB POWER -S	55269480	ETXY S
640	2A	*	K29-8226-08	KNOB POWER -S	55269480	HMM2 S
640	2A	*	K29-8228-08	KNOB POWER -BK	55266200	KPEY S
C	-	-	N09-5269-08	SCREW 3X18	55127290	
644	1B	*	W02-2947-08	SMPS MODULE	55274690	ETXY
644	1B	*	W02-2947-08	SMPS MODULE	55274690	HMM2
644	1B	*	W02-2948-08	SMPS MODULE KP	55329440	KP
645	2C	*	W02-2951-08	MAIN PCB ASSY	55291270	KP
645	2C	*	W02-2952-08	MAIN PCB ASSY	55305890	ETXY
645	2C	*	W02-2953-08	MAIN PCB ASSY	55305940	HMM2
MAIN PCB						
C20B			CE04LW1A471M	ELECTRO	470UF	10WV
C20C			CE04LW1A471M	ELECTRO	470UF	10WV
C20G			CE04LW1A471M	ELECTRO	470UF	10WV
C20R			CE04LW1A471M	ELECTRO	470UF	10WV
C20S			CE04LW1A471M	ELECTRO	470UF	10WV
C20Y			CE04LW1A471M	ELECTRO	470UF	10WV
C21B			CK73GB1H332K	CHIP C	3300PF	K
C21C			CK73GB1H332K	CHIP C	3300PF	K
C21G			CK73GB1H332K	CHIP C	3300PF	K
C21R			CK73GB1H332K	CHIP C	3300PF	K
C21S			CK73GB1H332K	CHIP C	3300PF	K
C21Y			CK73GB1H332K	CHIP C	3300PF	K
C22B			CK73GB1C104Z	CHIP C	0.10UF	Z
C22C			CK73GB1C104Z	CHIP C	0.10UF	Z
C22G			CK73GB1C104Z	CHIP C	0.10UF	Z
C22R			CK73GB1C104Z	CHIP C	0.10UF	Z
C22S			CK73GB1C104Z	CHIP C	0.10UF	Z
C22Y			CK73GB1C104Z	CHIP C	0.10UF	Z
C23B			CE04LW1C221M	ELECTRO	220UF	16WV
C23C			CE04LW1C221M	ELECTRO	220UF	16WV
C23G			CE04LW1C221M	ELECTRO	220UF	16WV
C23R			CE04LW1C221M	ELECTRO	220UF	16WV

L : Scandinavia K : USA P : Canada R : Mexico C : China I : Malaysia
 Y : PX(Far East,Hawaii) T : England E : Europe G : Germany V : China(Shanghai)
 B : AAFES(Europe) X : Australia Q : Russia H : Korea M : Other Areas indicates safety critical components.

* New Parts

Parts without **Parts No.** are not supplied.
Les articles non mentionnés dans le **Parts No.** ne sont pas fournis.
Teile ohne **Parts No.** werden nicht geliefert.

3

Ref. No	Address	New Parts	Parts No.	Description	Quantity	Unit	Desti-nation	Re-marks
C23S			CE04LW1C221M	ELECTRO	220UF	16WV		
C23Y			CE04LW1C221M	ELECTRO	220UF	16WV		
C24B			CC73GCH1H391J	CHIP C	390PF	J		
C24C			CC73GCH1H391J	CHIP C	390PF	J		
C24G			CC73GCH1H391J	CHIP C	390PF	J		
C24R			CC73GCH1H391J	CHIP C	390PF	J		
C24S			CC73GCH1H391J	CHIP C	390PF	J		
C24Y			CC73GCH1H391J	CHIP C	390PF	J		
C25B			CC73GCH1H391J	CHIP C	390PF	J		
C25C			CC73GCH1H391J	CHIP C	390PF	J		
C25G			CC73GCH1H391J	CHIP C	390PF	J		
C25R			CC73GCH1H391J	CHIP C	390PF	J		
C25S			CC73GCH1H391J	CHIP C	390PF	J		
C25Y			CC73GCH1H391J	CHIP C	390PF	J		
C201,202			CK73GB1C104Z	CHIP C	0.10UF	Z		
C203			CK73GB1H103K	CHIP C	0.010UF	K		
C204			CE04LW1A101M	ELECTRO	100UF	10WV		
C205			CK73GB1H103K	CHIP C	0.010UF	K		
C206			CE04LW1A101M	ELECTRO	100UF	10WV		
C207,208			CK73GB1C104Z	CHIP C	0.10UF	Z		
C209			CK73GB1H103K	CHIP C	0.010UF	K		
C210			CE04LW1A101M	ELECTRO	100UF	10WV		
C211-214			CC73GCH1H100D	CHIP C	10PF	D		
C215			CK73GB1C104Z	CHIP C	0.10UF	Z		
C216			CC73GCH1H471J	CHIP C	470PF	J		
C217-219			CK73GB1C104Z	CHIP C	0.10UF	Z		
C220			CK73GB1H103K	CHIP C	0.010UF	K		
C221			CE04LW1A101M	ELECTRO	100UF	10WV		
C222-225			CK73GB1C104Z	CHIP C	0.10UF	Z		
C226,227			CC73GCH1H680J	CHIP C	68PF	J		
C228-230			CE04LW1C470M	ELECTRO	47UF	16WV		
C232			CE04LW1A101M	ELECTRO	100UF	10WV		
C233			CE04LW0J471M	ELECTRO	470UF	6.3WV		
C234			CK73GB1C104Z	CHIP C	0.10UF	Z		
C235			CC73GCH1H100D	CHIP C	10PF	D		
C236-241			CC73GCH1H101J	CHIP C	100PF	J		
C242-244			CC73GCH1H100D	CHIP C	10PF	D		
C251			CK73GB1C104Z	CHIP C	0.10UF	Z		
C252			CE04LW1H010M	ELECTRO	1.0UF	50WV		
C254			CE04LW1C101M	ELECTRO	100UF	16WV		
C311			CE04LW1A101M	ELECTRO	100UF	10WV		
C312			CK73GB1C104Z	CHIP C	0.10UF	Z		
C313,314			CC73GCH1H100D	CHIP C	10PF	D		
C401-403			CK73GB1C104Z	CHIP C	0.10UF	Z		
C404,405			CK73GB1H102K	CHIP C	1000PF	K		
C406			CE04LW1A101M	ELECTRO	100UF	10WV		
C501			CC73GCH1H200J	CHIP C	20PF	J		
C502,503			CC73GCH1H220J	CHIP C	22PF	J	KPYH	
C502,503			CC73GCH1H240J	CHIP C	24PF	J	ETXMM2	
C504			CK73GB1C104Z	CHIP C	0.10UF	Z		
C505			CE04LW0J471M	ELECTRO	470UF	6.3WV		
KC01			CE04LW1C100M	ELECTRO	10UF	16WV	HMM2	
KC02,03			CK73GB1C104Z	CHIP C	0.10UF	Z	HMM2	
KC04			CE04LW1C100M	ELECTRO	10UF	16WV	HMM2	
KC05			CK73GB1C104Z	CHIP C	0.10UF	Z	HMM2	

L : Scandinavia K : USA P : Canada R : Mexico C : China I : Malaysia
Y : PX(Far East,Hawaii) T : England E : Europe G : Germany V : China(Shanghai)
Y : AAFES(Europe) X : Australia Q : Russia H : Korea M : Other Areas Δ indicates safety critical components.

* New Parts

Parts without **Parts No.** are not supplied.
Les articles non mentionnés dans le **Parts No.** ne sont pas fournis.
Teile ohne **Parts No.** werden nicht geliefert.

4

Ref. No	Address	New Parts	Parts No.	Description	Quantity	Unit	Desti-nation	Re-marks
KC06-08			CE04LW1C100M	ELECTRO	10UF	16WV	HMM2	
KC09,10			CC73GCH1H470J	CHIP C	47PF	J	HMM2	
KC11			CE04LW1C100M	ELECTRO	10UF	16WV	HMM2	
KC12			CK73GB1C104Z	CHIP C	0.10UF	Z	HMM2	
CP21			E40-8985-08	CONN 1.25MM 19	55124600			
CP22,23			E35-3010-08	CONN 1.0MM 15 F	55125910			
CP24			E40-8985-08	CONN 1.25MM 19	55124600			
CP25			E40-8987-08	CONN 1.25MM 29	55138650			
CP26			E40-8777-08	CONN 2.0MM 5 MA	55123320		HMM2	
CP27			E40-8765-08	CONN 2.0MM 7 MA	55090060			
CP28			E40-8771-08	CONN 2.5MM 02 M	55164790			
KL01-03			L90-0363-08	LF-SMD 2U2H +10	55188040		HMM2	
L20B		*	L90-0400-08	LF-SMD 2U7H +10	55190450			
L20C		*	L90-0400-08	LF-SMD 2U7H +10	55190450			
L20G		*	L90-0400-08	LF-SMD 2U7H +10	55190450			
L20R		*	L90-0400-08	LF-SMD 2U7H +10	55190450			
L20S		*	L90-0400-08	LF-SMD 2U7H +10	55190450			
L20Y		*	L90-0400-08	LF-SMD 2U7H +10	55190450			
L201-203			L90-0363-08	LF-SMD 2U2H +10	55188040			
L204-206			L32-1047-08	FBEAD SURFACE M55126670				
L207			L90-0361-08	LF-SMD 22U0H +1	55185100			
L209			L90-0363-08	LF-SMD 2U2H +1055188040				
L210			L32-1047-08	FBEAD SURFACE M55126670				
L211			L32-1045-08	FBEAD SURFACE M55126710				
L501			L32-1047-08	FBEAD SURFACE M55126670				
R415			L32-1047-08	FBEAD SURFACE M55126670				
X501			L77-2326-08	FILQZ 27M0 HZ +	55128980			
C253			CE04LW1C100M	CE 10U0F +20% 115002130				
J201-203			RK73GB1J000J	CHIP R	0	J	1/16W	
J211,212			RK73GB1J000J	CHIP R	0	J	1/16W	
J301			RK73GB1J000J	CHIP R	0	J	1/16W	
KR01-04			RK73GB1J470J	CHIP R	47	J	1/16W	HMM2
KR05			RK73GB1J100J	CHIP R	10	J	1/16W	HMM2
KR06-08			RK73GB1J470J	CHIP R	47	J	1/16W	HMM2
L208			RK73GB1J000J	CHIP R	0	J	1/16W	
L301			RK73GB1J000J	CHIP R	0	J	1/16W	
R19B			RK73GB1J271J	CHIP R	270	J	1/16W	
R19C			RK73GB1J271J	CHIP R	270	J	1/16W	
R19G			RK73GB1J271J	CHIP R	270	J	1/16W	
R19R			RK73GB1J271J	CHIP R	270	J	1/16W	
R19S			RK73GB1J271J	CHIP R	270	J	1/16W	
R19Y			RK73GB1J271J	CHIP R	270	J	1/16W	
R20B			RK73GB1J100J	CHIP R	10	J	1/16W	
R20C			RK73GB1J100J	CHIP R	10	J	1/16W	
R20G			RK73GB1J100J	CHIP R	10	J	1/16W	
R20R			RK73GB1J100J	CHIP R	10	J	1/16W	
R20S			RK73GB1J100J	CHIP R	10	J	1/16W	
R20Y			RK73GB1J100J	CHIP R	10	J	1/16W	
R21B			RK73GB1J821J	CHIP R	820	J	1/16W	
R21C			RK73GB1J821J	CHIP R	820	J	1/16W	
R21G			RK73GB1J821J	CHIP R	820	J	1/16W	
R21R			RK73GB1J821J	CHIP R	820	J	1/16W	
R21S			RK73GB1J821J	CHIP R	820	J	1/16W	

L : Scandinavia K : USA P : Canada R : Mexico C : China I : Malaysia
Y : PX(Far East,Hawaii) T : England E : Europe G : Germany V : China(Shanghai)
Y : AAFES(Europe) X : Australia Q : Russia H : Korea M : Other Areas Δ indicates safety critical components.

PARTS LIST

DVF-3060/3060-S/3060K-S

* New Parts
Parts without **Parts No.** are not supplied.
Les articles non mentionnés dans le **Parts No.** ne sont pas fournis.
Teile ohne **Parts No.** werden nicht geliefert.

5

Ref. No	Add-ress	New Parts	Parts No.	Description	Desti-nation	Re-marks
R21Y			RK73GB1J821J	CHIP R 820 J 1/16W		
R22B			RK73GB1J222J	CHIP R 2.2K J 1/16W		
R22C			RK73GB1J222J	CHIP R 2.2K J 1/16W		
R22G			RK73GB1J222J	CHIP R 2.2K J 1/16W		
R22R			RK73GB1J222J	CHIP R 2.2K J 1/16W		
R22S			RK73GB1J222J	CHIP R 2.2K J 1/16W		
R22Y			RK73GB1J222J	CHIP R 2.2K J 1/16W		
R23B			RK73GB1J750J	CHIP R 75 J 1/16W		
R23C			RK73GB1J750J	CHIP R 75 J 1/16W		
R23G			RK73GB1J750J	CHIP R 75 J 1/16W		
R23R			RK73GB1J750J	CHIP R 75 J 1/16W		
R23S			RK73GB1J750J	CHIP R 75 J 1/16W		
R23Y			RK73GB1J750J	CHIP R 75 J 1/16W		
R24B			RK73GB1J120J	CHIP R 12 J 1/16W		
R24C			RK73GB1J120J	CHIP R 12 J 1/16W		
R24G			RK73GB1J120J	CHIP R 12 J 1/16W		
R24R			RK73GB1J120J	CHIP R 12 J 1/16W		
R24S			RK73GB1J120J	CHIP R 12 J 1/16W		
R24Y			RK73GB1J120J	CHIP R 12 J 1/16W		
R25B			RK73GB1J8R2J	CHIP R 8.2 J 1/16W		
R25C			RK73GB1J8R2J	CHIP R 8.2 J 1/16W		
R25G			RK73GB1J8R2J	CHIP R 8.2 J 1/16W		
R25R			RK73GB1J8R2J	CHIP R 8.2 J 1/16W		
R25S			RK73GB1J8R2J	CHIP R 8.2 J 1/16W		
R25Y			RK73GB1J8R2J	CHIP R 8.2 J 1/16W		
R26B			RK73GB1J000J	CHIP R 0 J 1/16W		
R26C			RK73GB1J000J	CHIP R 0 J 1/16W		
R26G			RK73GB1J000J	CHIP R 0 J 1/16W		
R26R			RK73GB1J000J	CHIP R 0 J 1/16W		
R26S			RK73GB1J000J	CHIP R 0 J 1/16W		
R26Y			RK73GB1J000J	CHIP R 0 J 1/16W		
R201-204			RK73GB1J101J	CHIP R 100 J 1/16W		
R205			RK73GB1J183J	CHIP R 18K J 1/16W		
R207			RK73GB1J470J	CHIP R 47 J 1/16W	HMM2	
R208			RK73GB1J271J	CHIP R 270 J 1/16W	HMM2	
R209			RK73GB1J183J	CHIP R 18K J 1/16W		
R210-213			RK73GB1J470J	CHIP R 47 J 1/16W		
R214			RK73GB1J472J	CHIP R 4.7K J 1/16W		
R215			RK73GB1J470J	CHIP R 47 J 1/16W		
R216			RK73GB1J472J	CHIP R 4.7K J 1/16W		
R217			RK73GB1J470J	CHIP R 47 J 1/16W		
R221			RK73GB1J101J	CHIP R 100 J 1/16W		
R222,223			RK73GB1J470J	CHIP R 47 J 1/16W		
R230			RK73GB1J000J	CHIP R 0 J 1/16W		
R231,232			RK73GB1J470J	CHIP R 47 J 1/16W		
R233			RK73GB1J101J	CHIP R 100 J 1/16W		
R234			RK73GB1J470J	CHIP R 47 J 1/16W		
R236			RK73GB1J473J	CHIP R 47K J 1/16W		
R237-241			RK73GB1J470J	CHIP R 47 J 1/16W		
R242-245			RK73GB1J103J	CHIP R 10K J 1/16W		
R246,247			RK73GB1J472J	CHIP R 4.7K J 1/16W		
R248			RK73GB1J103J	CHIP R 10K J 1/16W		
R249			RK73GB1J000J	CHIP R 0 J 1/16W		
R250			RK73GB1J102J	CHIP R 1.0K J 1/16W		
R251			RK73GB1J103J	CHIP R 10K J 1/16W		

L : Scandinavia K : USA P : Canada R : Mexico C : China I : Malaysia
 Y : PX(Far East,Hawaii) T : England E : Europe G : Germany V : China(Shanghai)
 Y : AAFES(Europe) X : Australia Q : Russia H : Korea M : Other Areas Δ indicates safety critical components.

* New Parts
Parts without **Parts No.** are not supplied.
Les articles non mentionnés dans le **Parts No.** ne sont pas fournis.
Teile ohne **Parts No.** werden nicht geliefert.

6

Ref. No	Add-ress	New Parts	Parts No.	Description	Desti-nation	Re-marks
R252			RK73GB1J470J	CHIP R 47 J 1/16W		
R253			RK73GB1J103J	CHIP R 10K J 1/16W		
R254			RK73GB1J100J	CHIP R 10 J 1/16W		
R255			RK73GB1J103J	CHIP R 10K J 1/16W		
R256			RK73GB1J470J	CHIP R 47 J 1/16W		
R262,263			RK73GB1J470J	CHIP R 47 J 1/16W		
R264,265			RK73GB1J750J	CHIP R 75 J 1/16W		
R266			RK73GB1J100J	CHIP R 10 J 1/16W		
R267,268			RK73GB1J470J	CHIP R 47 J 1/16W		
R269,270			RK73GB1J182J	CHIP R 1.8K J 1/16W		
R273,274			RK73GB1J101J	CHIP R 100 J 1/16W		
R276			RK73GB1J000J	CHIP R 0 J 1/16W		
R277,278			RK73GB1J221J	CHIP R 220 J 1/16W		
R286,287			RK73GB1J221J	CHIP R 220 J 1/16W		
R288			RK73GB1J103J	CHIP R 10K J 1/16W		
R289-293			RK73GB1J470J	CHIP R 47 J 1/16W		
R298			RK73GB1J103J	CHIP R 10K J 1/16W		
R301-309			RK73GB1J101J	CHIP R 100 J 1/16W		
R310-313			RK73GB1J472J	CHIP R 4.7K J 1/16W		
R314			RK73GB1J000J	CHIP R 0 J 1/16W		
R315			RK73GB1J473J	CHIP R 47K J 1/16W		
R321,322			RK73GB1J471J	CHIP R 470 J 1/16W		
R323			RK73GB1J562J	CHIP R 5.6K J 1/16W		
R324			RK73GB1J103J	CHIP R 10K J 1/16W		
R325			RK73GB1J683J	CHIP R 68K J 1/16W		
R326-328			RK73GB1J103J	CHIP R 10K J 1/16W		
R329			RK73GB1J220J	CHIP R 22 J 1/16W		
R330			RK73GB1J220J	CHIP R 22 J 1/16W		
R331			RK73GB1J562J	CHIP R 5.6K J 1/16W		
R332			RK73GB1J182J	CHIP R 1.8K J 1/16W		
R333			RK73GB1J473J	CHIP R 47K J 1/16W		
R336-338			RK73GB1J000J	CHIP R 0 J 1/16W		
R339			RK73GB1J100J	CHIP R 10 J 1/16W		
R401-404			RK73GB1J470J	CHIP R 47 J 1/16W		
R405,406			RK73GB1J103J	CHIP R 10K J 1/16W		
R407-410			RK73GB1J470J	CHIP R 47 J 1/16W		
R411,412			RK73GB1J000J	CHIP R 0 J 1/16W		
R413			RK73GB1J473J	CHIP R 47K J 1/16W		
R501			RK73GB1J101J	CHIP R 100 J 1/16W		
R502			RK73GB1J560J	CHIP R 56 J 1/16W		
R503			RK73GB1J105J	CHIP R 1.0M J 1/16W		
RA31-37			R90-1333-08	RCA 47R0 OHM +555129820		
RA41-48			R90-1333-08	RCA 47R0 OHM +555129820		
D201			UZ5V6	D-ZENER 1N5232B20414280		
D202			RB501V-40	D-SLP RB441Q-4055165360		
D203,204			1N4148	D-SLP 1N4148 1070436540		
IC21			ST15508	IC-VIDEOPROC ST55130350	HMM2	
IC21			ST15519	IC-VIDEOPROC ST55130350	KPETXY	
IC22			M24C02WMN6	IC-EEPROM M24C020940740		
IC23			KA8082	IC-MOTORCIR FAN55116380		
IC31			HY57V641620HGT	IC-DRAM HY57V6455236130		
IC41			M29W800AT	IC-MEMFLASH M2955136720		
IC51			M74HCU04MIR	IC-LOGIC M74HCU55133310		
KIC1		*	WM8739EDS	IC-CONV WM8739E55329430	HMM2	

L : Scandinavia K : USA P : Canada R : Mexico C : China I : Malaysia
 Y : PX(Far East,Hawaii) T : England E : Europe G : Germany V : China(Shanghai)
 Y : AAFES(Europe) X : Australia Q : Russia H : Korea M : Other Areas Δ indicates safety critical components.

DVF-3060/3060-S/3060K-S
PARTS LIST

* New Parts

Parts without **Parts No.** are not supplied.
Les articles non mentionnés dans le **Parts No.** ne sont pas fournis.
Teile ohne **Parts No.** werden nicht geliefert.

7

Ref. No	Address	New Parts	Parts No.	Description	Destination	Remarks
Q22B Q22C Q22G Q22R Q22S			KTN2907 KTN2907 KTN2907 KTN2907 KTN2907	TR-SLPLF KTN29055138690 TR-SLPLF KTN29055138690 TR-SLPLF KTN29055138690 TR-SLPLF KTN29055138690 TR-SLPLF KTN29055138690		
Q22Y Q201-203 Q204			KTN2907 KTC3875S KTA1504S	TR-SLPLF KTN29055138690 TR-SLPSWA KTC3820970460 TR-SLPSWA KTA1520970480		
FRONT PCB						
FL91		*	HNV-12SM20	DISPLAY HNV-12S55291380		
C901 C902 C903 C904,905			CK73GB1H102K CK73GB1C473K CE04EW1C100M CK73GB1C104Z	CHIP C 1000PF K CHIP C 0.047UF K ELECTRO 10UF 16WV CHIP C 0.10UF Z		
R901-909 R910 R911 R912-915			RK73GB1J103J RK73GB1J472J RK73GB1J101J RD14GB2E150J	CHIP R 10K J 1/16W CHIP R 4.7K J 1/16W CHIP R 100 J 1/16W FL-PROOF RD 15 J 1/4W		
SW91-97			S70-0087-08	SWITACT VERTICA55145270		
D901,902 D904 D905 IC91 IC91		*	1N4148 1N4148 1N4004 PT6311 UPD16311	D-SLP 1N4148 1070436540 D-SLP 1N4148 1070436540 D-SR 1N4004 40020415060 IC-DISPLAY PT6355009420 IC(FL DRIVER)D120920150		
RM91			W02-2801-08	IC-REMOTE NJL6355156010		
REAR/SCART PCB						
C701 C702 C703 C704 C713,714			CE04LW1A221M CK73GB1C104Z CE04LW1C101M CC73GCH1H100D CE04LW1H100M	ELECTRO 220UF 10WV CHIP C 0.10UF Z ELECTRO 100UF 16WV CHIP C 10PF D ELECTRO 10UF 50WV	ET ET ET ET	
C715 C716-718 C719 C722 C801			CE04LW1C101M CC73GCH1H101J CE04LW1A101M CK73GB1C104Z CK73GB1H102K	ELECTRO 100UF 16WV CHIP C 100PF J ELECTRO 100UF 10WV CHIP C 0.10UF Z CHIP C 1000PF K	ET ET ET ET	
C802 C803 C804 C805 C806			CE04LW0J102M CK73GB1H103K CC73GCH1H101J CE04LW1C470M CC73GCH1H561J	ELECTRO 1000UF 6.3WV CHIP C 0.010UF K CHIP C 100PF J ELECTRO 47UF 16WV CHIP C 560PF J		
C807 C808 C809 C810 C811			CE04LW1H100M CC73GCH1H561J CE04LW1H100M CC73GCH1H561J CE04LW1C470M	ELECTRO 10UF 50WV CHIP C 560PF J ELECTRO 10UF 50WV CHIP C 560PF J ELECTRO 47UF 16WV		
C812 C813 C814 C815 C816			CK73GB1H222K CC73GCH1H331J CE04LW1C470M CK73GB1H222K CE04LW1C470M	CHIP C 2200PF K CHIP C 330PF J ELECTRO 47UF 16WV CHIP C 2200PF K ELECTRO 47UF 16WV		
C817			CC73GCH1H101J	CHIP C 100PF J		

L : Scandinavia K : USA P : Canada R : Mexico C : China I : Malaysia
Y : PX(Far East,Hawaii) T : England E : Europe G : Germany V : China(Shanghai)
Y : AAFES(Europe) X : Australia Q : Russia H : Korea M : Other Areas Δ indicates safety critical components.

* New Parts

Parts without **Parts No.** are not supplied.
Les articles non mentionnés dans le **Parts No.** ne sont pas fournis.
Teile ohne **Parts No.** werden nicht geliefert.

8

Ref. No	Address	New Parts	Parts No.	Description	Destination	Remarks
C819 C821-824 C825 C826 C828			CE04LW1C470M CC73GCH1H100D CE04LW0J331M CC73GCH1H100D CC73GCH1H100D	ELECTRO 47UF 16WV CHIP C 10PF D ELECTRO 330UF 6.3WV CHIP C 10PF D CHIP C 10PF D		
C829 C831 C832 C833 C834			CC73GCH1H331J CE04LW1A101M CE04LW1C470M CC73GCH1H101J CE04LW1C470M	CHIP C 330PF J ELECTRO 100UF 10WV ELECTRO 47UF 16WV CHIP C 100PF J ELECTRO 47UF 16WV		
C836 C872 C873			CE04LW1C221M CK73GB1C104Z CC73GCH1H100D	ELECTRO 220UF 16WV CHIP C 0.10UF Z CHIP C 10PF D		
CP81 CP82 JK71 JK81 JK82		*	E40-8987-08 E40-8985-08 E40-8779-08 E63-1244-08 E63-1286-08	CONN 1.25MM 29 55138650 CONN 1.25MM 19 55124600 CON SCART DUAL 55176340 CON PHONO SCKT 55164750 CON PHONO SCKT 55099830	ET	
JK83 JK84 JK84			E63-1243-08 E63-1192-08 E63-1192-08	CON DIN SCKT MI 55149520 CON PHONO SCKT 55149420 CON PHONO SCKT 55149420	HMM2 KPXY	
L703,704 L705-707 L801 L802-804 L812,813			L32-1045-08 L32-1047-08 L32-1047-08 L32-1045-08 L32-1047-08	FBEAD SURFACE M55126710 FBEAD SURFACE M55126670 FBEAD SURFACE M55126670 FBEAD SURFACE M55126710 FBEAD SURFACE M55126670	ET ET	
J801 R701,702 R704 R705 R706			RK73GB1J000J RK73GB1J101J RK73GB1J000J RK73GB1J102J RK73GB1J471J	CHIP R 0 J 1/16W CHIP R 100 J 1/16W CHIP R 0 J 1/16W CHIP R 1.0K J 1/16W CHIP R 470 J 1/16W	ET ET ET ET	
R707 R708-710 R714,715 R716 R717			RK73GB1J680J RK73GB1J102J RK73GB1J681J RK73GB1J102J RK73GB1J000J	CHIP R 68 J 1/16W CHIP R 1.0K J 1/16W CHIP R 680 J 1/16W CHIP R 1.0K J 1/16W CHIP R 0 J 1/16W	ET ET ET ET ET	
R718 R719 R720 R721 R722			RK73GB1J100J RK73GB1J000J RK73GB1J100J RK73GB1J000J RK73GB1J100J	CHIP R 10 J 1/16W CHIP R 0 J 1/16W CHIP R 10 J 1/16W CHIP R 0 J 1/16W CHIP R 10 J 1/16W	ET ET ET ET ET	
R723 R724 R730 R731 R733			RK73GB1J102J RK73GB1J181J RK73GB1J510J RK73GB1J390J RK73GB1J000J	CHIP R 1.0K J 1/16W CHIP R 180 J 1/16W CHIP R 51 J 1/16W CHIP R 39 J 1/16W CHIP R 0 J 1/16W	ET ET ET ET ET	
R734 R736 R801 R802 R803			RK73GB1J470J RK73GB1J000J RK73GB1J101J RK73GB1J000J RK73GB1J472J	CHIP R 47 J 1/16W CHIP R 0 J 1/16W CHIP R 100 J 1/16W CHIP R 0 J 1/16W CHIP R 4.7K J 1/16W	ET ET	
R804 R805 R806			RK73GB1J100J RK73GB1J181J RK73GB1J101J	CHIP R 10 J 1/16W CHIP R 180 J 1/16W CHIP R 100 J 1/16W		

L : Scandinavia K : USA P : Canada R : Mexico C : China I : Malaysia
Y : PX(Far East,Hawaii) T : England E : Europe G : Germany V : China(Shanghai)
Y : AAFES(Europe) X : Australia Q : Russia H : Korea M : Other Areas Δ indicates safety critical components.

PARTS LIST

DVF-3060/3060-S/3060K-S

* New Parts
Parts without **Parts No.** are not supplied.
Les articles non mentionnés dans le **Parts No.** ne sont pas fournis.
Teile ohne **Parts No.** werden nicht geliefert.

9

Ref. No	Add-ress	New Parts	Parts No.	Description	Desti-nation	Re-marks
R808-814			RK73GB1J000J	CHIP R 0 J 1/16W		
R815			RK73GB1J912J	CHIP R 9.1K J 1/16W		
R816			RK73GB1J473J	CHIP R 47K J 1/16W		
R817			RK73GB1J000J	CHIP R 0 J 1/16W		
R818			RK73GB1J912J	CHIP R 9.1K J 1/16W		
R819			RK73GB1J104J	CHIP R 100K J 1/16W		
R820			RK73GB1J000J	CHIP R 0 J 1/16W		
R823-825			RK73GB1J000J	CHIP R 0 J 1/16W		
R826			RK73GB1J101J	CHIP R 100 J 1/16W		
R827			RK73GB1J331J	CHIP R 330 J 1/16W		
R828			RK73GB1J473J	CHIP R 47K J 1/16W		
R829			RK73GB1J000J	CHIP R 0 J 1/16W	HMM2	
R829			RK73GB1J000J	CHIP R 0 J 1/16W	KPXY	
R831			RK73GB1J824J	CHIP R 820K J 1/16W		
R832-834			RK73GB1J000J	CHIP R 0 J 1/16W		
R835			RK73GB1J473J	CHIP R 47K J 1/16W		
R836,837			RK73GB1J000J	CHIP R 0 J 1/16W		
R838			RK73GB1J471J	CHIP R 470 J 1/16W		
R839,840			RK73GB1J562J	CHIP R 5.6K J 1/16W		
R841,842			RK73GB1J330J	CHIP R 33 J 1/16W		
R843			RS14AB3D220J	FL-PROOF RS 22 J 2W		
R844			RK73GB1J000J	CHIP R 0 J 1/16W		
R845			RS14AB3D220J	FL-PROOF RS 22 J 2W		
R863,864			RK73GB1J392J	CHIP R 3.9K J 1/16W		
R865			RK73GB1J104J	CHIP R 100K J 1/16W		
R866			RK73GB1J101J	CHIP R 100 J 1/16W		
R867			RK73GB1J331J	CHIP R 330 J 1/16W		
R868-871			RK73GB1J000J	CHIP R 0 J 1/16W		
R872-877			RK73GB1J121J	CHIP R 120 J 1/16W	HMM2	
R872-877			RK73GB1J121J	CHIP R 120 J 1/16W	KPXY	
R878			RK73GB1J103J	CHIP R 10K J 1/16W		
R883			RK73GB1J102J	CHIP R 1.0K J 1/16W		
R888			RK73GB1J472J	CHIP R 4.7K J 1/16W		
R890,891			RK73GB1J000J	CHIP R 0 J 1/16W		
D701,702			1SS355	D-SLP 1SS355 3520496510	ET	
D703			ZNR5V1B0.2W	D-ZENER UDZ 5.155177710	ET	
D705-710			ZNR5V1B0.2W	D-ZENER UDZ 5.155177710	ET	
D804			1SS355	D-SLP 1SS355 3520496510		
D805			1N4148	D-SLP 1N4148 1070436540		
D806			1SS355	D-SLP 1SS355 3520496510		
D810-815			ZNR5V1B0.2W	D-ZENER UDZ 5.155177710	KPXY	
D810-815			ZNR5V1B0.2W	D-ZENER UDZ 5.155177710	HMM2	
D816-819			ZNR5V1B0.2W	D-ZENER UDZ 5.155177710		
D821,822			ZNR5V1B0.2W	D-ZENER UDZ 5.155177710		
IC81		*	WM8728	IC-CONV WM8728 55291470		
IC82			BA4560F	IC-OPERAMP BA4555128990		
IC84			GP1F32T	D-LEM GP1F32T R55164740		
IC85			KIA7806	IC-REGPOSFXD KI20361320		
J873			1N4148	D-SLP 1N4148 1070436540		
Q701			KTC3875S	TR-SLPSWA KTC3820970460	ET	
Q702			DTC114YKA	TR-SSD DTC114YK55133180	ET	
Q704			DTC114YKA	TR-SSD DTC114YK55133180		
Q705			KTC3875S	TR-SLPSWA KTC3820970460	ET	
Q801			KTC3875S	TR-SLPSWA KTC3820970460		
Q802			KTA1504S	TR-SLPSWA KTA1520970480		

L : Scandinavia K : USA P : Canada R : Mexico C : China I : Malaysia
Y : PX(Far East,Hawaii) T : England E : Europe G : Germany V : China(Shanghai)
Y : AAFES(Europe) X : Australia Q : Russia H : Korea M : Other Areas Δ indicates safety critical components .

* New Parts
Parts without **Parts No.** are not supplied.
Les articles non mentionnés dans le **Parts No.** ne sont pas fournis.
Teile ohne **Parts No.** werden nicht geliefert.

10

Ref. No	Add-ress	New Parts	Parts No.	Description	Desti-nation	Re-marks
Q803			DTC323T	TR-SSD DTC323TK55039430		
Q804			KRA107S	TR-SSD DTA114YK55133190		
Q805			DTC114YKA	TR-SSD DTC114YK55133180		
Q809			KTD1304	TR-SLPSWA KTD1355138710	HMM2	
Q809			KTD1304	TR-SLPSWA KTD1355138710	KPXY	
Q811			DTC323T	TR-SSD DTC323TK55039430		
Q812			KTD1304	TR-SLPSWA KTD1355138710		
Q813			KTD1304	TR-SLPSWA KTD1355138710	HMM2	
Q813			KTD1304	TR-SLPSWA KTD1355138710	KPXY	
Q814			KTC3875S	TR-SLPSWA KTC3820970460		
Q815			KTD1304	TR-SLPSWA KTD1355138710	HMM2	
Q815			KTD1304	TR-SLPSWA KTD1355138710	KPXY	
Q816-817			KTD1304	TR-SLPSWA KTD1355138710		
MIC PCB (DVF-3060K-S only)						
MC01			CE04LW1H0R1M	ELECTRO 0.1UF 50WV		
MC02,03			CE04LW1H100M	ELECTRO 10UF 50WV		
MC04			CE04LW1H4R7M	ELECTRO 4.7UF 50WV		
MC05			CE04LW1HR47M	ELECTRO 0.47UF 50WV		
MC06			CC73GCH1H471J	CHIP C 470PF J		
MC07			CE04LW1H100M	ELECTRO 10UF 50WV		
MC08			CE04LW1HR47M	ELECTRO 0.47UF 50WV		
MC09			CC73GCH1H681J	CHIP C 680PF J		
MC10			CK73GB1H102K	CHIP C 1000PF K		
MJK1		*	E11-0961-08	CONN-PHJAC 6.3555088400		
MR01,02			RK73GB1J104J	CHIP R 100K J 1/16W		
MR03			RK73GB1J102J	CHIP R 1.0K J 1/16W		
MR04,05			RK73GB1J221J	CHIP R 220 J 1/16W		
MR06			RK73GB1J823J	CHIP R 82K J 1/16W		
MR07			RK73GB1J102J	CHIP R 1.0K J 1/16W		
MR08,09			RK73GB1J104J	CHIP R 100K J 1/16W		
MR10			RK73GB1J103J	CHIP R 10K J 1/16W		
MR11			RK73GB1J222J	CHIP R 2.2K J 1/16W		
MVR1			R32-0105-08	PR-ROT 10K0 OHM55146550		
MD01-04			1N4148	D-SLP 1N4148 1070436540		
MIC1			BA4558-1	IC(OP AMP X2)4520323370		

L : Scandinavia K : USA P : Canada R : Mexico C : China I : Malaysia
Y : PX(Far East,Hawaii) T : England E : Europe G : Germany V : China(Shanghai)
Y : AAFES(Europe) X : Australia Q : Russia H : Korea M : Other Areas Δ indicates safety critical components .

DVF-3060/3060-S/3060K-S

SPECIFICATIONS

[Type]

System DVD video player
 Signal read system Semiconductor laser

[D/A Conversion Section]

D/A conversion 24 Bit
 Oversampling 8 fs (Sampling frequency; 44.1, 48 kHz)
 4 fs (Sampling frequency; 96 kHz)

[Audio section]

Frequency response
 Sampling frequency ; 44.1 kHz 4 Hz ~ 20 kHz
 Sampling frequency ; 48 kHz 4 Hz ~ 22 kHz
 Sampling frequency ; 96 kHz 4 Hz ~ 42 kHz
 Signal to noise ratio More than 98 dB
 Dynamic range More than 95 dB
 Total harmonic distortion Less than 0.005 % (1 kHz)
 Channel separation More than 95 dB (1 kHz)
 Wow and flutter Below measurable limit
 Analog output level/impedance 2 V / 1 k Ω
 Digital output level/impedance
 COAXIAL 0.5 Vp-p / 75 Ω
 OPTICAL -21 dBm ~ -15 dBm (Wave length 660 nm)

[Video Section]

Video output format
 (For U.S.A., Canada and U.S. Military)
 NTSC
 (For other countries)
 NTSC/PAL
 Video compression
 DVD MPEG-2
 Composite video output level
 1 Vp-p (75 Ω load, sync. negative)
 S-video output level
 (Y-signal) 1 Vp-p (75 Ω load, sync. negative)
 (C-signal)
 NTSC 0.286 Vp-p (75 Ω)
 PAL 0.300 Vp-p (75 Ω)
 Horizontal resolution More than 480 lines
 Video signal to noise ratio More than 60 dB

[General]

Power consumption 16 W
 Dimensions W: 440 mm (17-5/16")
 H: 75 mm (2-15/16")
 D: 282 mm (11-1/8")
 Weight (net) 3.1 kg (6.8 lb)



KENWOOD follows a policy of continuous advancements in development. For this reason specifications may be changed without notice.

- Sufficient performance may not be exhibited at extremely cold locations (Where water freezes) .

DVF-3060/3060-S/3060K-S

KENWOOD CORPORATION

14-6, Dogenzaka 1-chome, Shibuya-ku, Tokyo, 150-8501 Japan

KENWOOD SERVICE CORPORATION

P.O BOX 22745, 2201 East Dominguez St., Long Beach, CA 90801-5745, U.S.A.

KENWOOD ELECTRONICS CANADA INC.

6070 Kestrel Road, Mississauga, Ontario, Canada L5T 1S8

KENWOOD ELECTRONICS LATIN AMERICA S.A.

P.O BOX 55-2791, Piso 6 plaza Chase, Cl. 47 y Aquilino de la Guardia Panama, Republic de Panama

KENWOOD ELECTRONICS BRASIL LTDA.

Alameda Ministro Rocha Azevedo No. 456, Edificio Jaú, 10o Andar, Cerqueira César, Cep 0140-001, São Paulo-SP-Brasil

KENWOOD ELECTRONICS U.K. LIMITED

KENWOOD House, Dwight Road, Watford, Herts., WD1 8EB., United Kingdom

KENWOOD ELECTRONICS BELGIUM N.V.

Leuvensesteenweg 248 J, 1800 Vilvoorde, Belgium

KENWOOD ELECTRONICS DEUTSCHLAND GMBH

Rembrücker Str. 15, 63150 Heusenstamm, Germany

KENWOOD ELECTRONICS FRANCE S.A.

13 Boulevard Ney, 75018 Paris, France

KENWOOD ELECTRONICS ITALIA S.p.A.

Via G. Sirtori, 7/9 20129, Milano, Italy

KENWOOD IBÉRICA S.A.

Bolivia, 239-08020 Barcelona, Spain

KENWOOD ELECTRONICS AUSTRALIA PTY. LTD.

(A.C.N. 001 499 074)

16 Giffnock Avenue, North Ryde, N.S.W. 2113, Australia

KENWOOD ELECTRONICS (HONG KONG) LTD.

Unit 3712-3724, Level 37, Tower 1, Metroplaza, 223 Hing Fong Road, Kwai Fong N.T., Hong Kong

KENWOOD ELECTRONICS GULF FZE

P.O.Box 61318, Jebel Ali, Dubai, U.A.E.

KENWOOD ELECTRONICS SINGAPORE PTE LTD.

No. 1 Genting Lane #02-02, KENWOOD Building, Singapore, 349544

KENWOOD ELECTRONICS (MALAYSIA) SDN BHD.

#4.01 Level 4, Wisma Academy Lot 4A, Jalan 19/1 46300 Petaling Jaya Selangor Darul Ehsan Malaysia

KENWOOD ELECTRONICS (THAILAND) CO., LTD.

2019 New Pechburi Road, Bangkapi, Huaykwang, Bangkok, 10320 Thailand